

Dark Green  
Roller  
ORNAMENT

*A LEGO® project by Chris McVeigh*  
[chrismcveigh.com](http://chrismcveigh.com)



| Element ID | Color             | Description                 | Quantity |
|------------|-------------------|-----------------------------|----------|
| 6010831    | Black             | Round Plate 2X2 W/Eye       | 1        |
| 4565388    | Bright Green      | Plate 2X2 W 1 Knob          | 8*       |
| 4142865    | Bright Red        | 2M Cross Axle W. Groove     | 2        |
| 4581308    | Bright Red        | Plate 2X2 W 1 Knob          | 8        |
| 4650244    | Earth Green       | Plate 2X3                   | 16       |
| 4211445    | Medium Stone Grey | Plate 1X4                   | 4        |
| 4599498    | Medium Stone Grey | Plate 1X4 W. 2 Knobs        | 8        |
| 6020990    | Silver Metallic   | Parabolic Ring              | 2        |
| 307001     | White             | Flat Tile 1X1               | 8        |
| 6051511    | White             | Plate 1X2 W. 1 Knob         | 16       |
| 4535737    | White             | Plate 2X1 W/Holder,Vertical | 16       |
| 403201     | White             | Plate 2X2 Round             | 2        |
| 4504369    | White             | Roof Tile 1X1X2/3, Abs      | 34       |
| 396001     | White             | Round Plate Ø32X6.4         | 2        |

\* Optional parts for alternate deco modes.

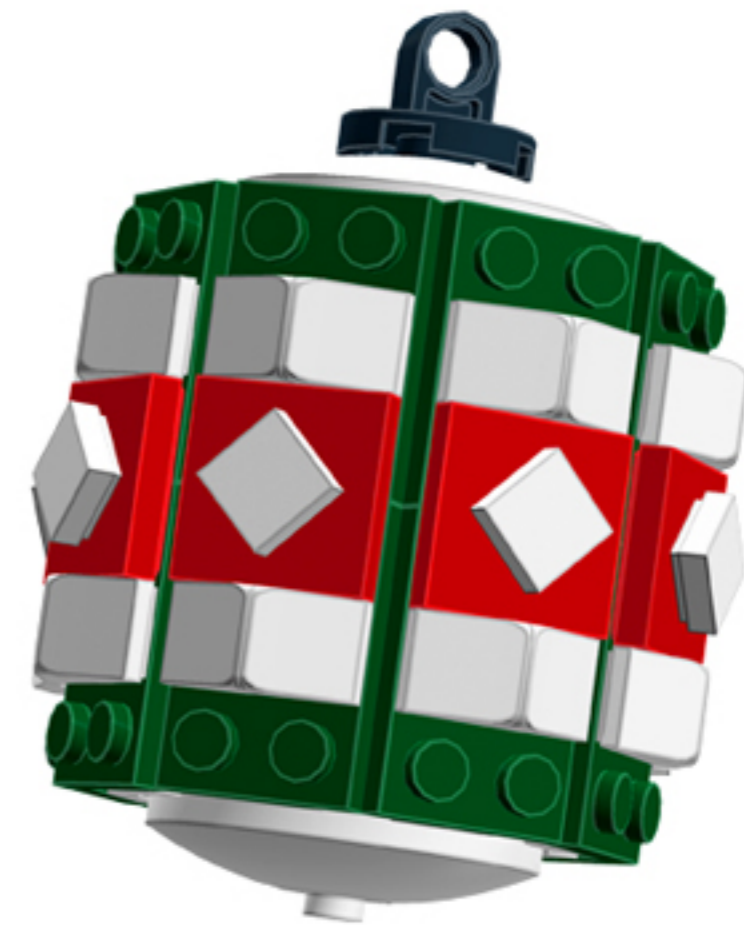

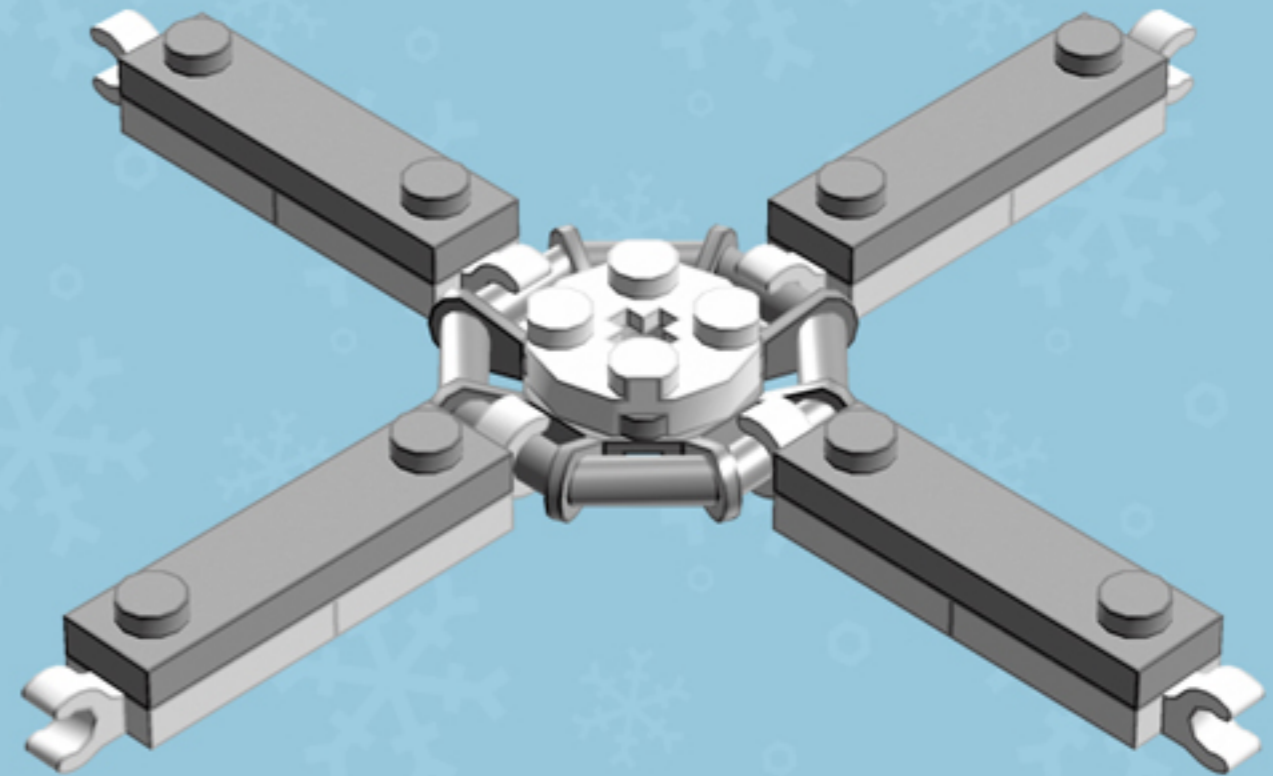
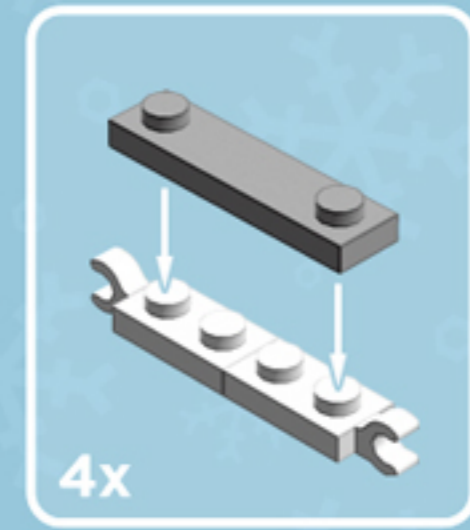

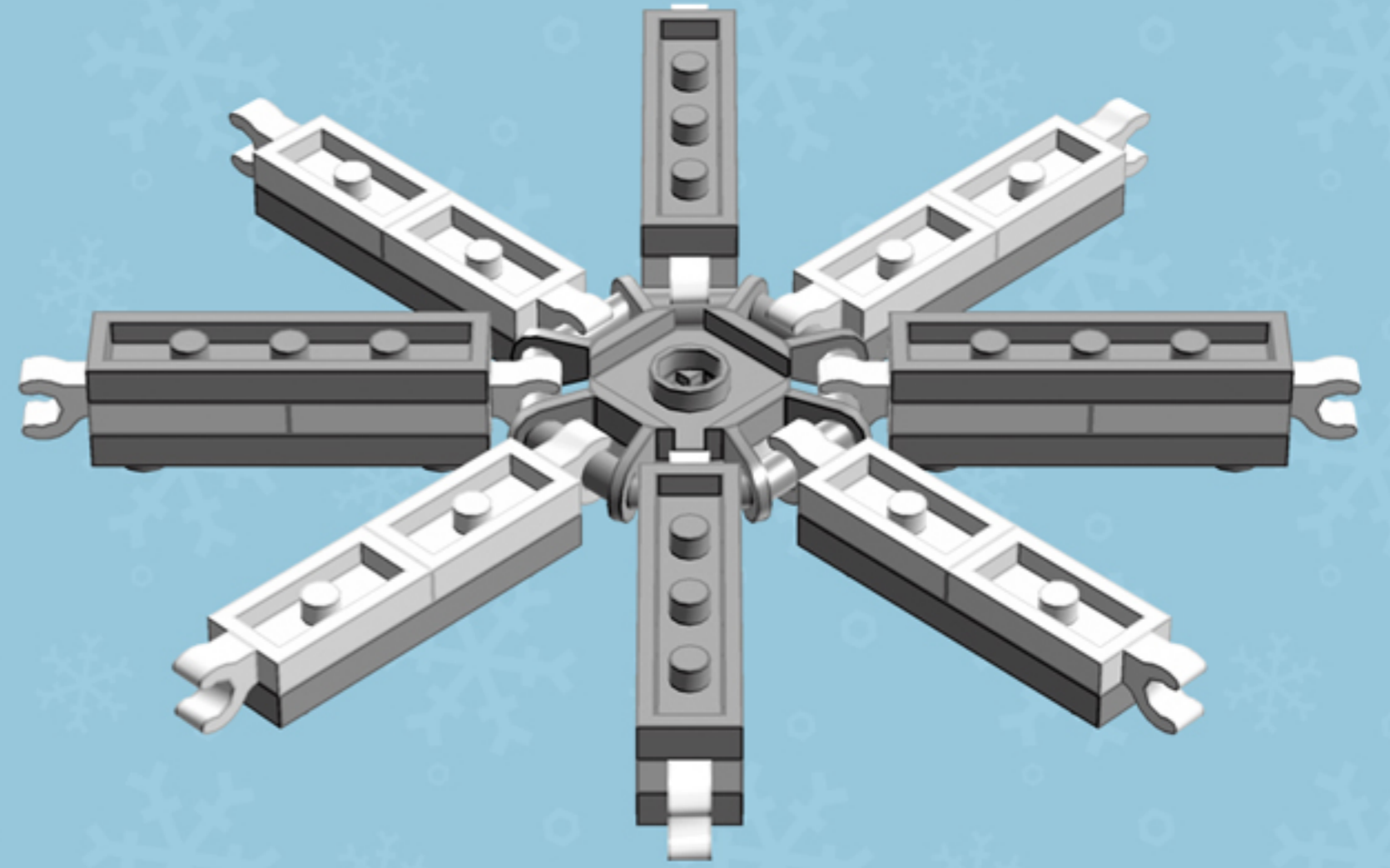
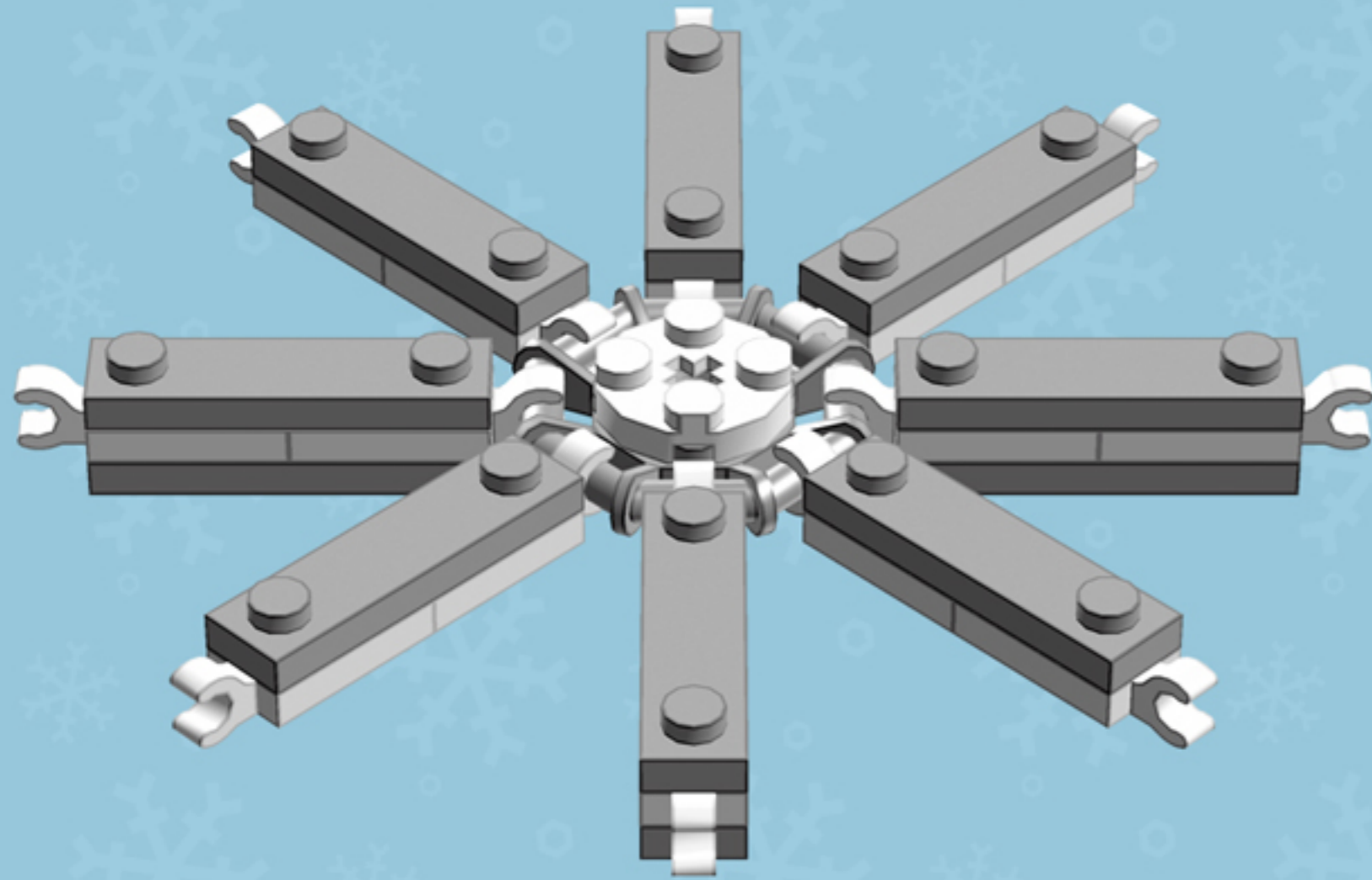
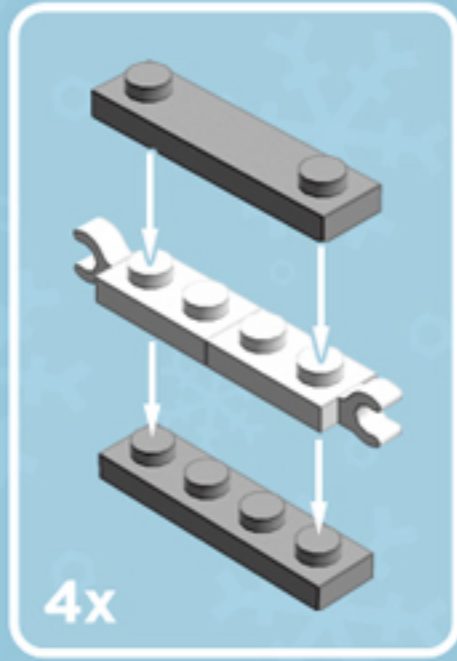

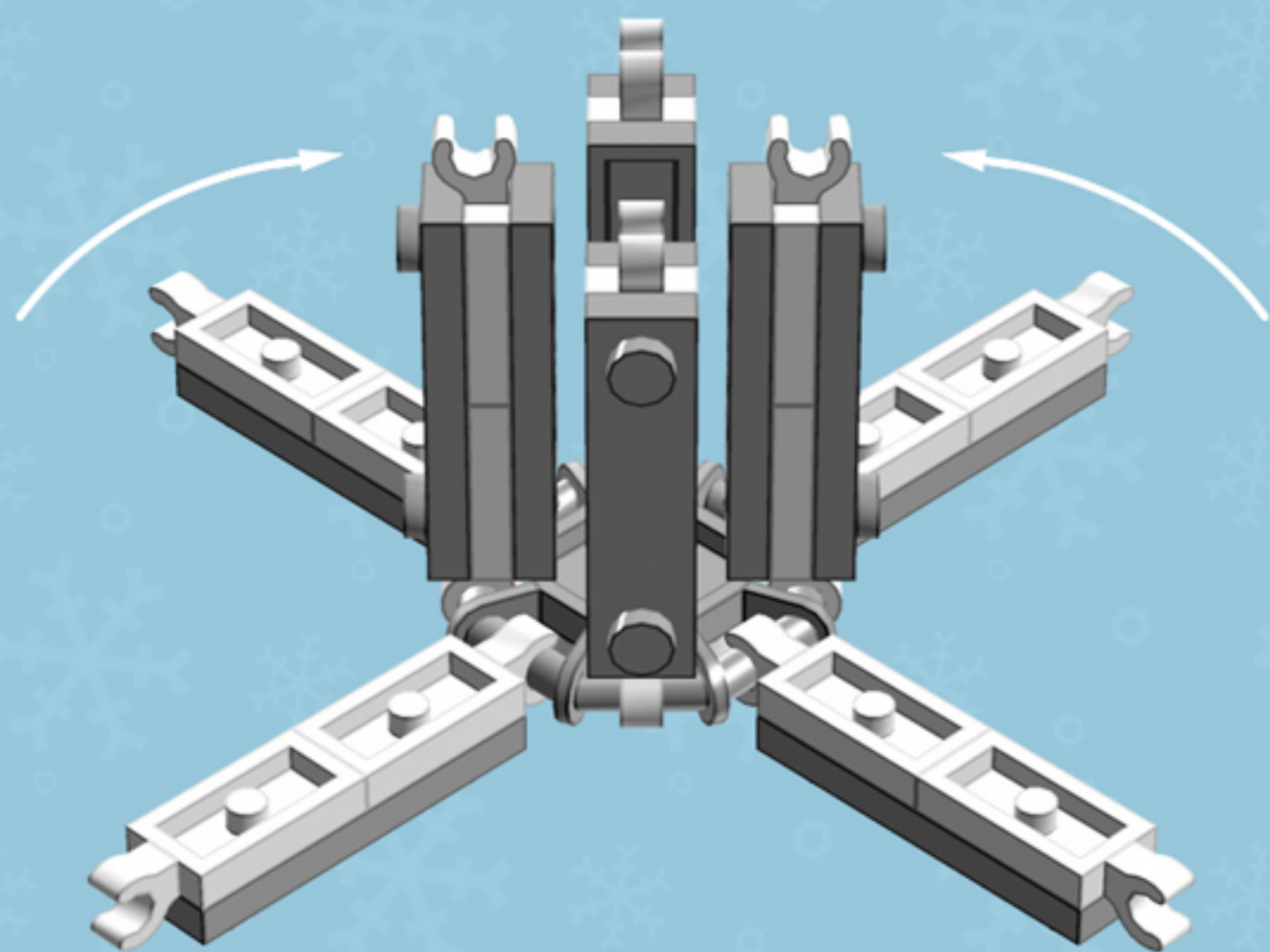

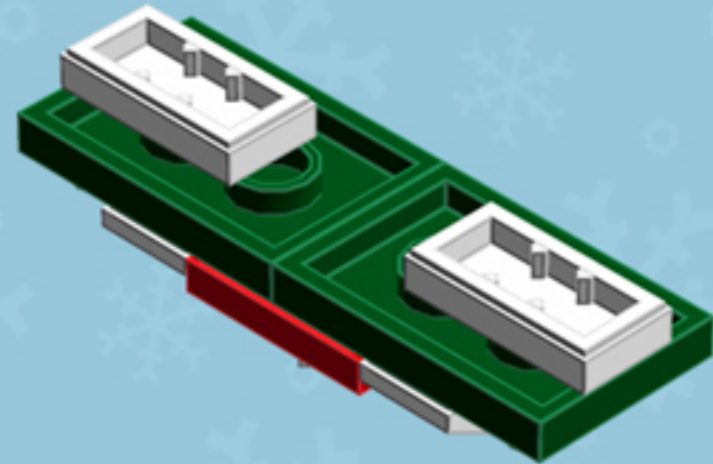
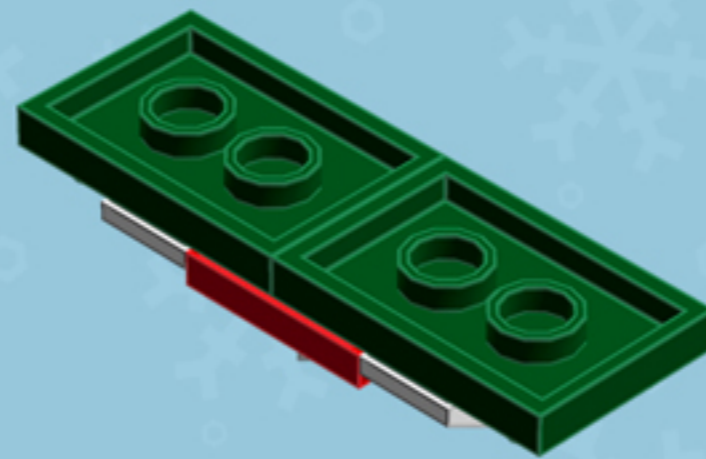
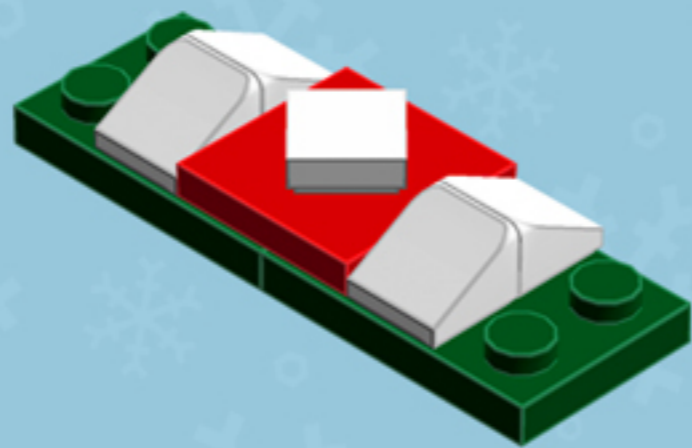
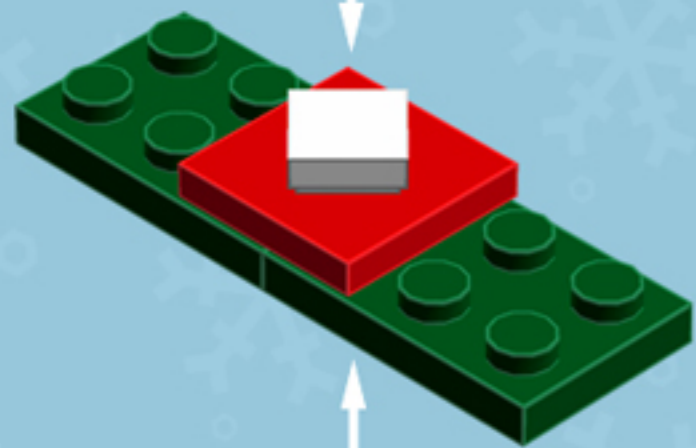

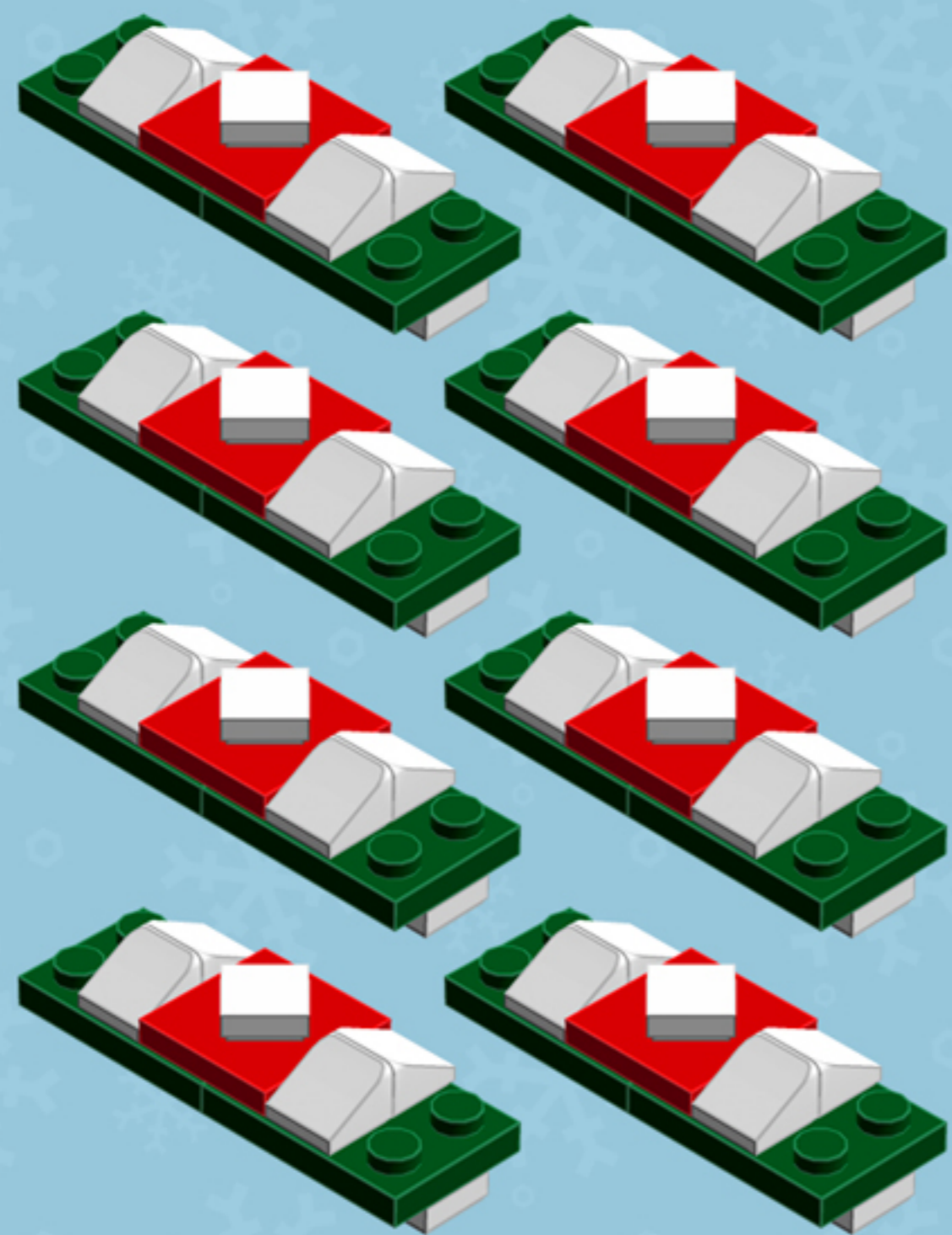

8x

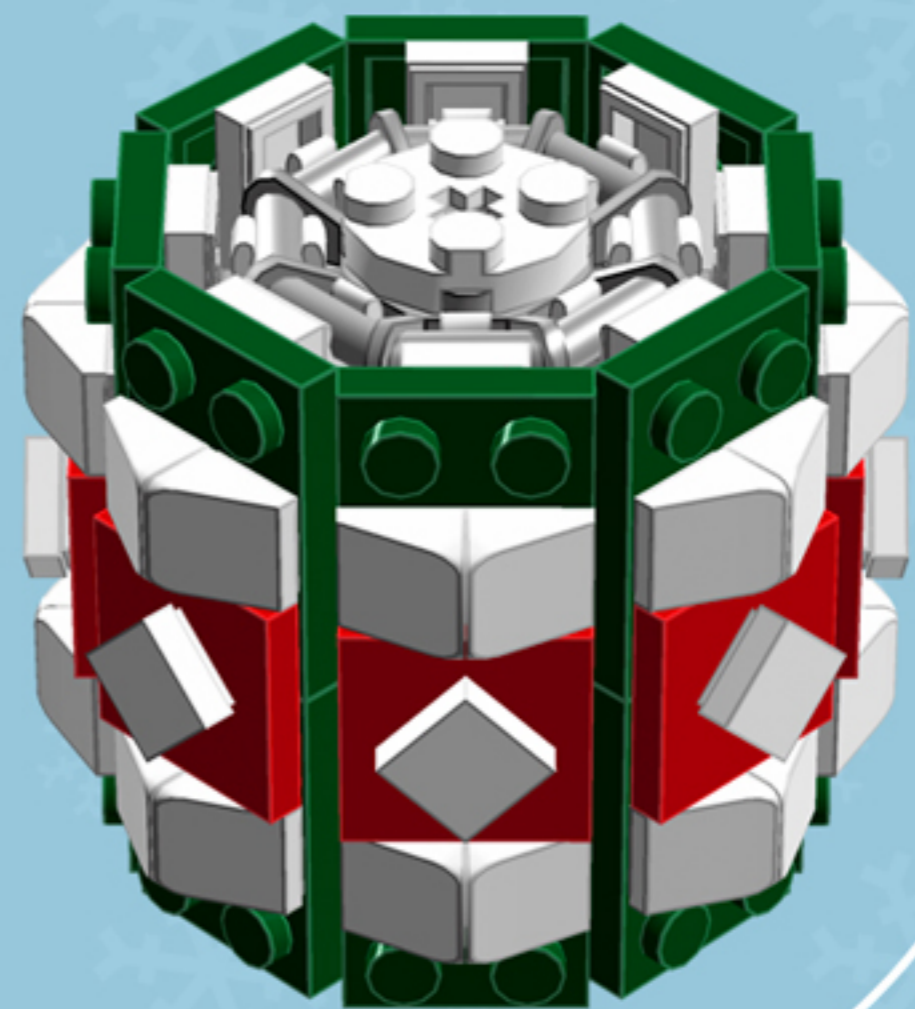
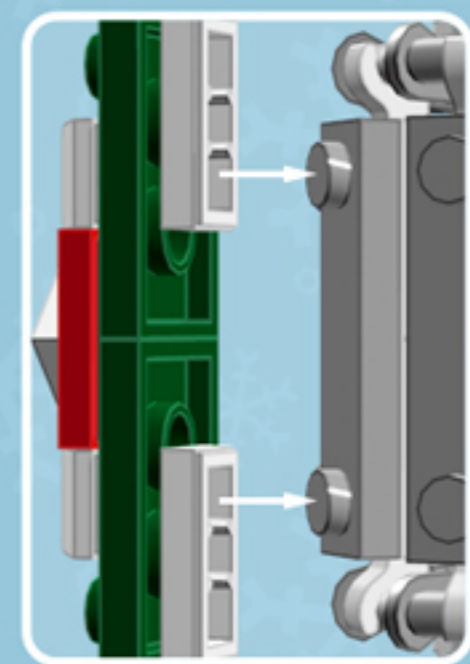

8x

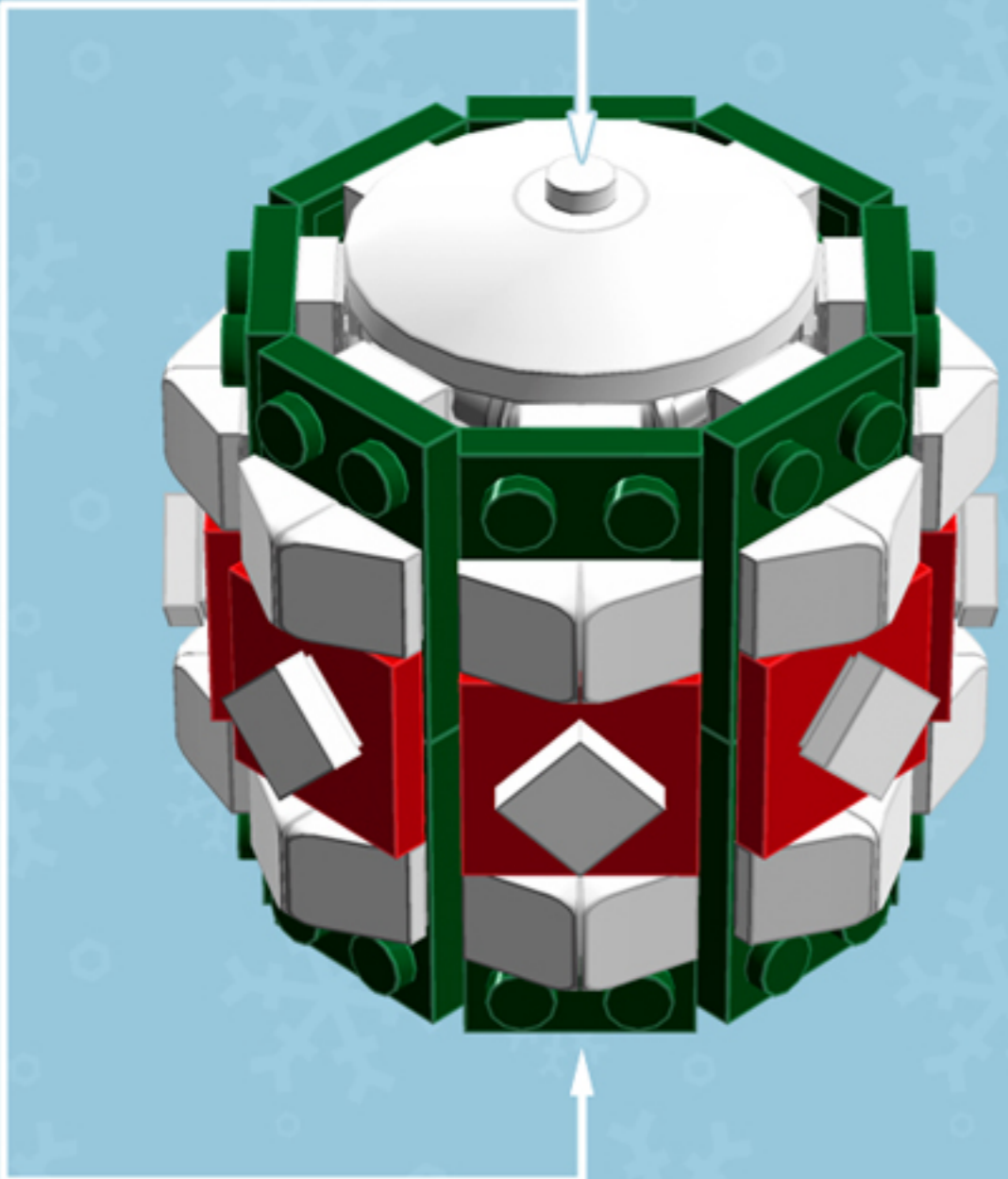



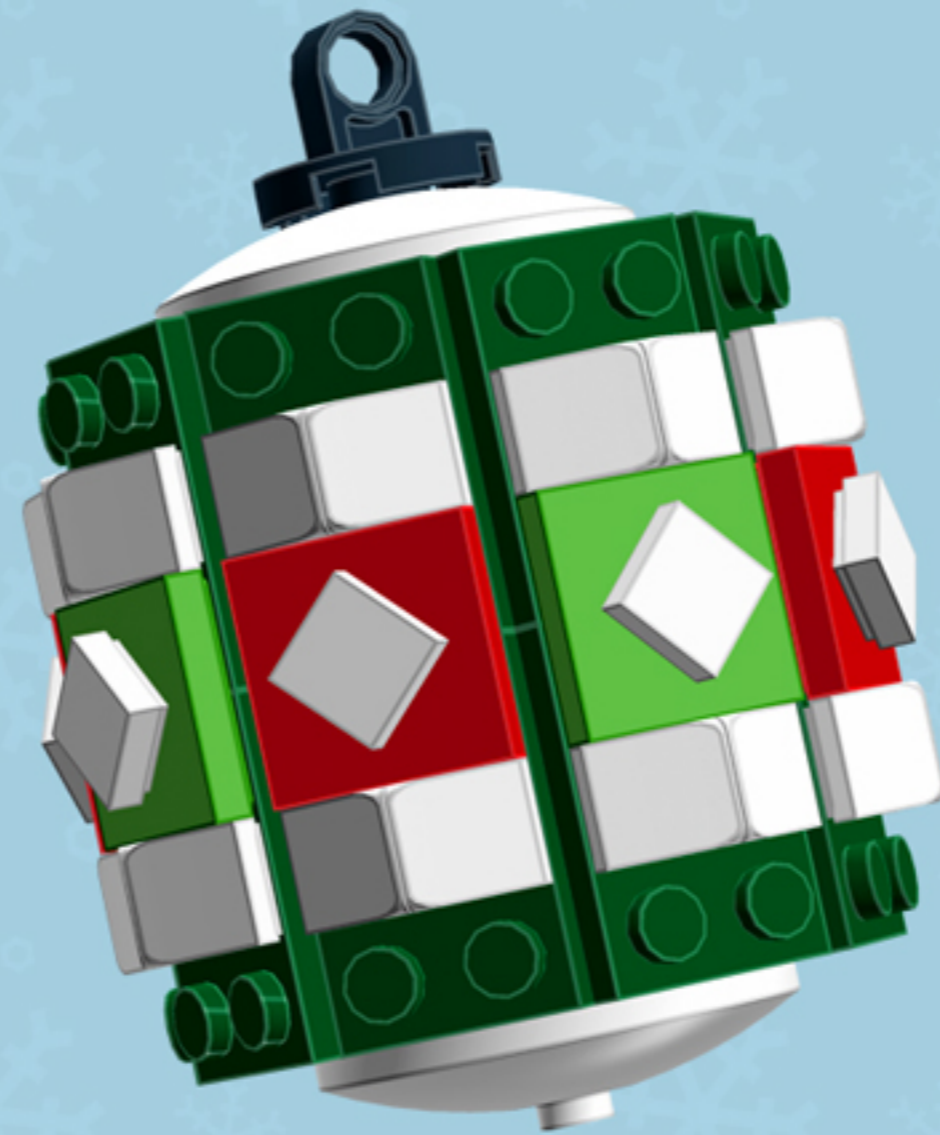

*Alternate Deco*

***For more fun builds,  
please pop by [chrismcveigh.com](http://chrismcveigh.com),  
visit me at [facebook.com/c.mcveigh.photos](https://facebook.com/c.mcveigh.photos),  
or follow me on twitter [@actionfigured](https://twitter.com/actionfigured)***

*Purchase custom building kits at [shop.chrismcveigh.com](http://shop.chrismcveigh.com)*

*These building guides are for personal use only. Unauthorized duplication, distribution and/or modification of these guides, in whole or in part, is strictly prohibited. The models contained within these guides are the copyright of Chris McVeigh, unless otherwise stated. Unauthorized reproduction of these models for resale, either in whole or as a building kit, is strictly prohibited.*

**© 2015 CHRIS MCVEIGH**

*LEGO is a registered trademark of The LEGO Group.*