



Fresh Spruce  
Trident<sup>XL</sup>  
**ORNAMENT**

*A LEGO® project by Chris McVeigh*  
[chrismcveigh.com](http://chrismcveigh.com)



Element ID	Color	Description	Quantity
6055225	Earth Green	Plate W. Bow 1X2X2/3	12
4502595	Medium Stone Grey	3-Branch Cross Axle W/Cross H.	1
4535768	Medium Stone Grey	Cross Axle 9M	1
4655080	Sand Green	Plate 1X2	3
6069257	Sand Green	Plate 1X3	6
6080431	Sand Green	Plate W. Bow 2X2X2/3	6
4652205	Sand Green	Roof Tile 1X1X2/3, Abs	12
6030875	Silver Metallic	Tool Set (Box Wrench)	1

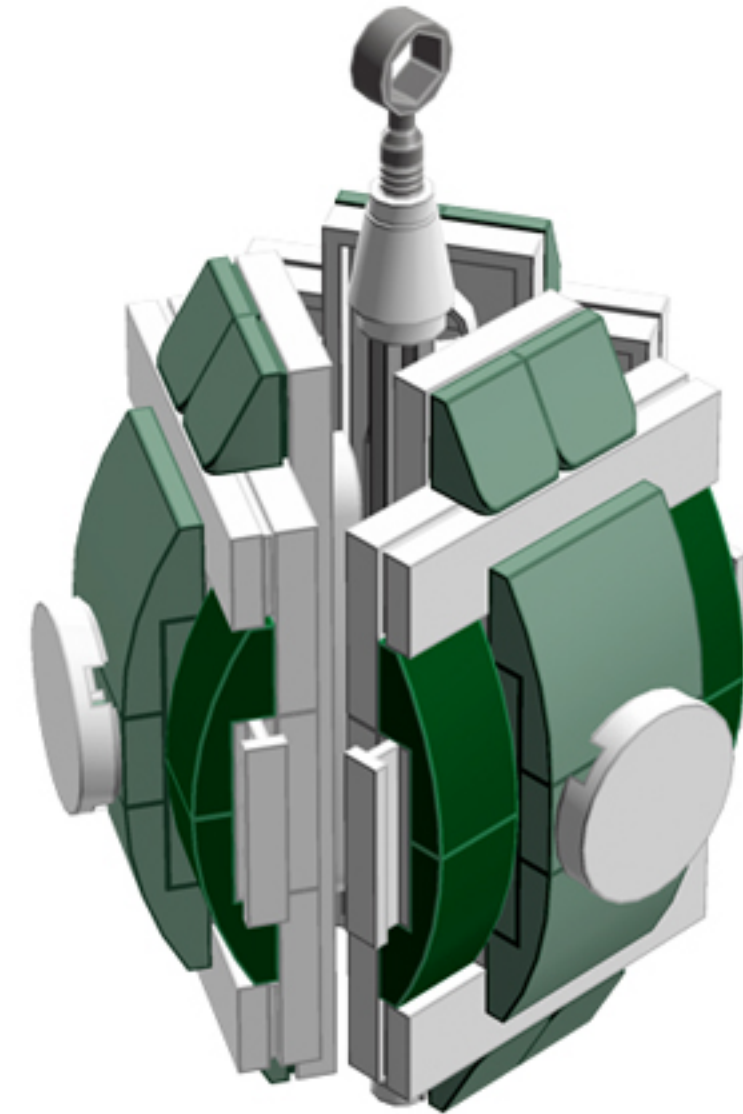





Element ID	Color	Description	Quantity
243101	White	Flat Tile 1X4	6
415001	White	Flat Tile 2X2, Round	3
4518400	White	Nose Cone Small 1X1	2
6051511	White	Plate 1X2 W. 1 Knob	12
4249563	White	Plate 1X2 With Slide	6
302001	White	Plate 2X4	6
370901	White	Plate 2X4, 3X $\varnothing$ 4.9	3
4527945	White	Plate 2X8 W. Holes	3
4527839	White	Technic Rotor, 2 Blades	3

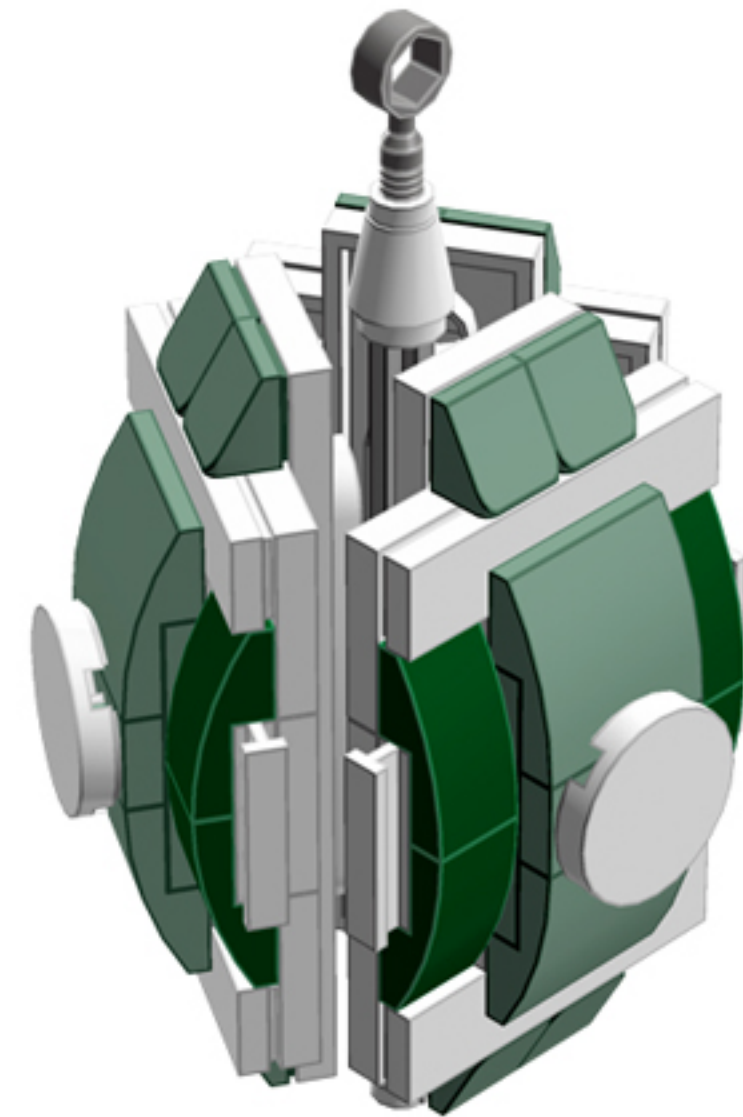

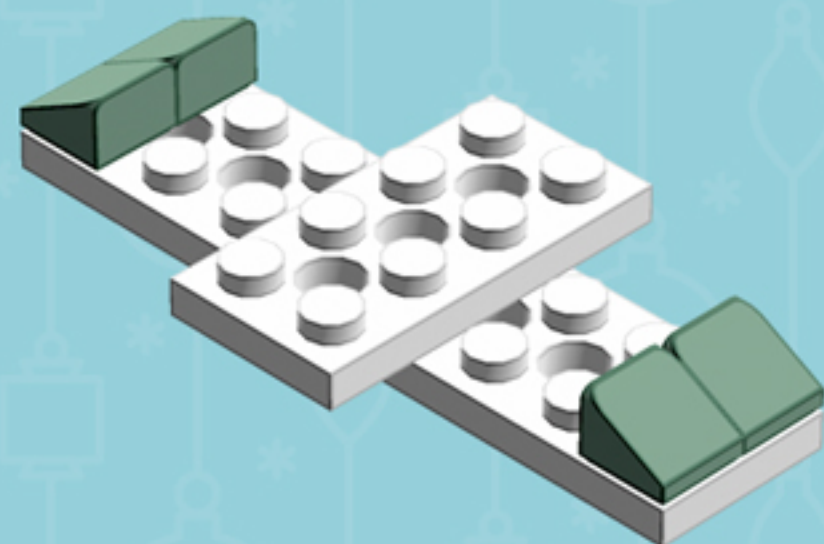
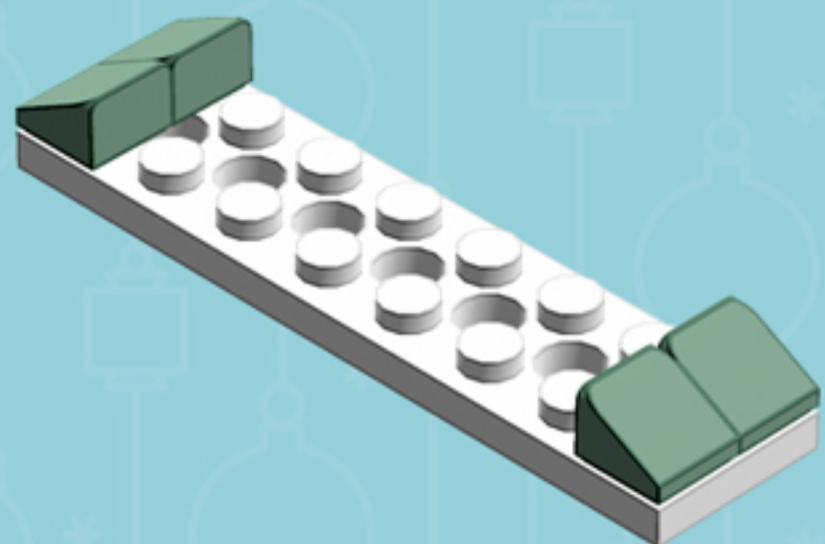



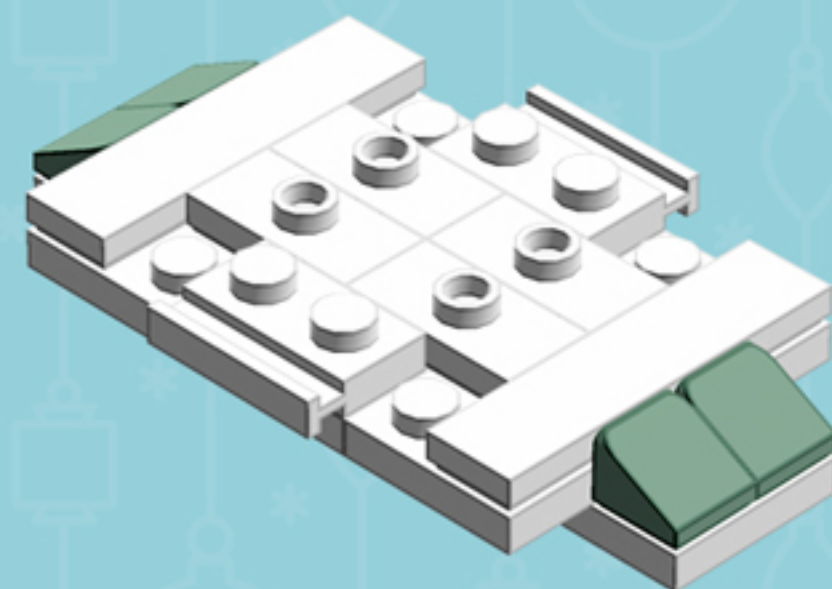
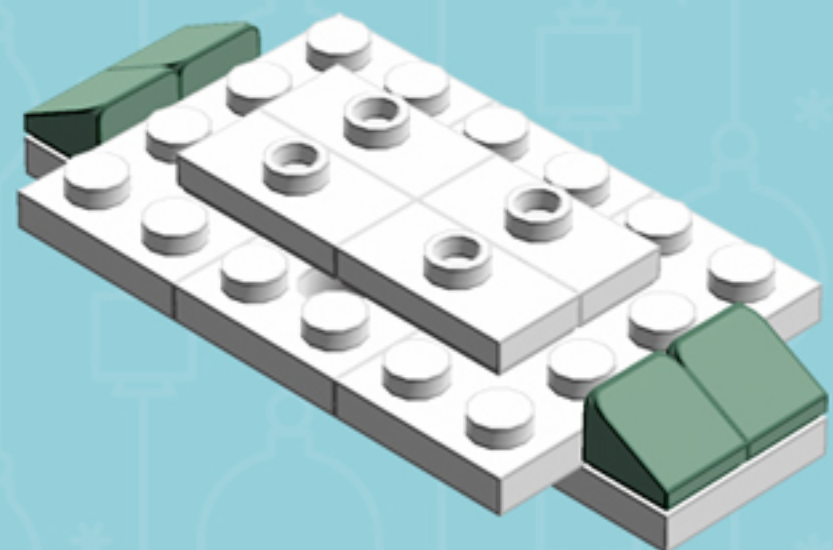
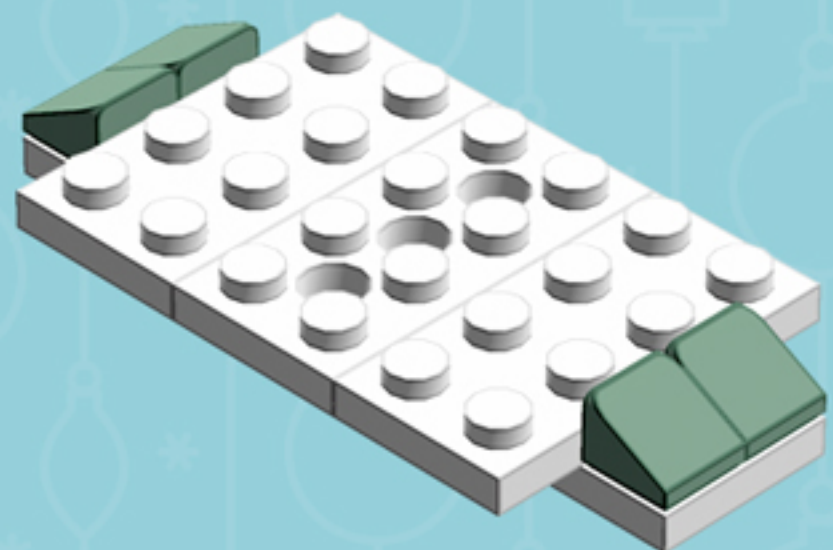

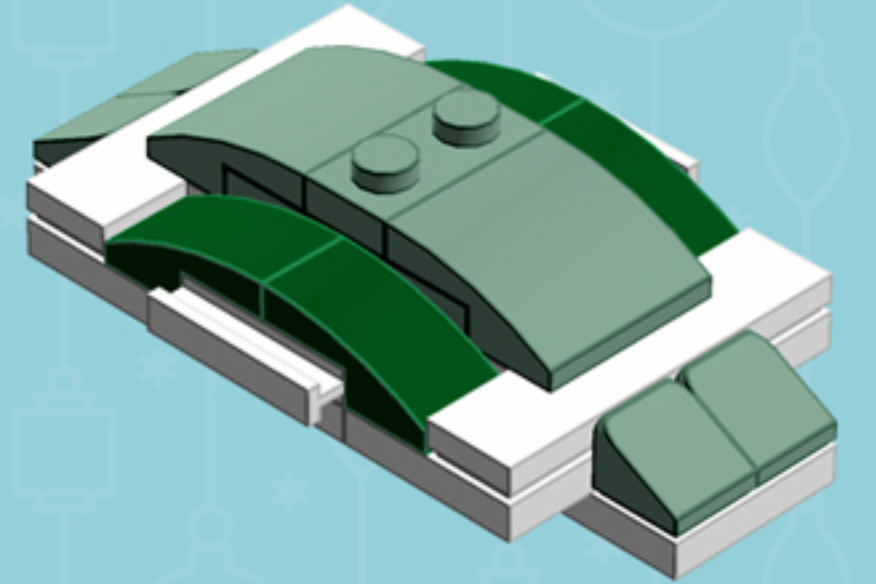
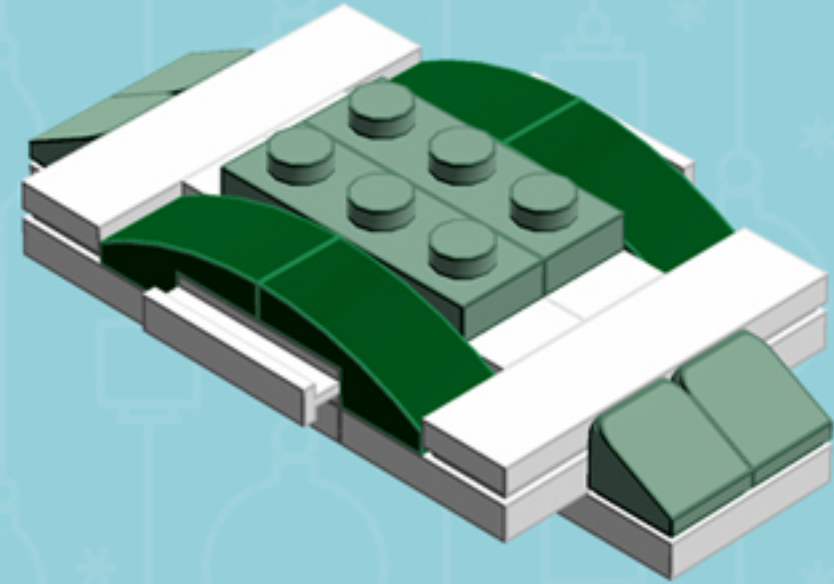
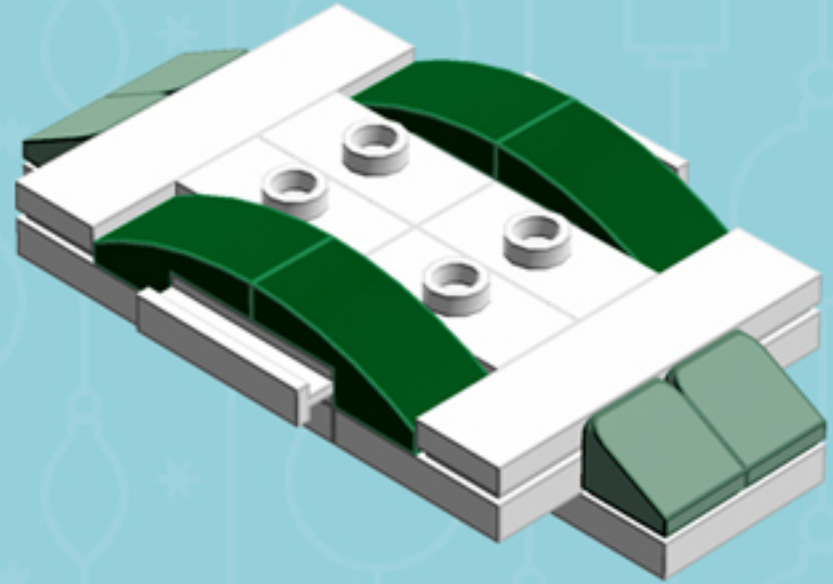



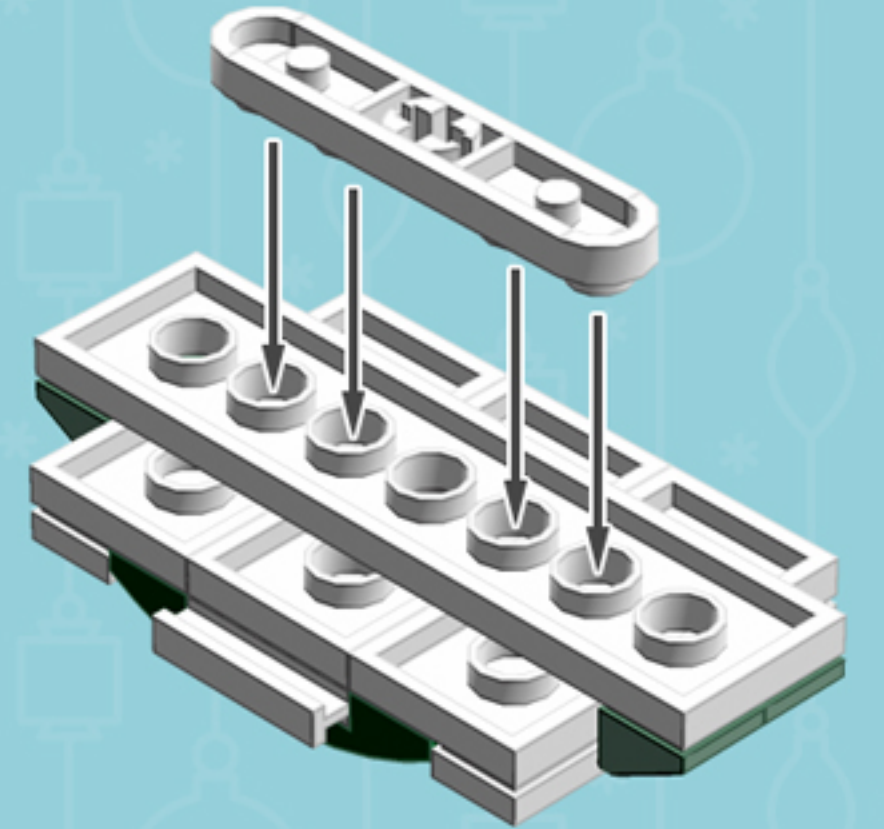
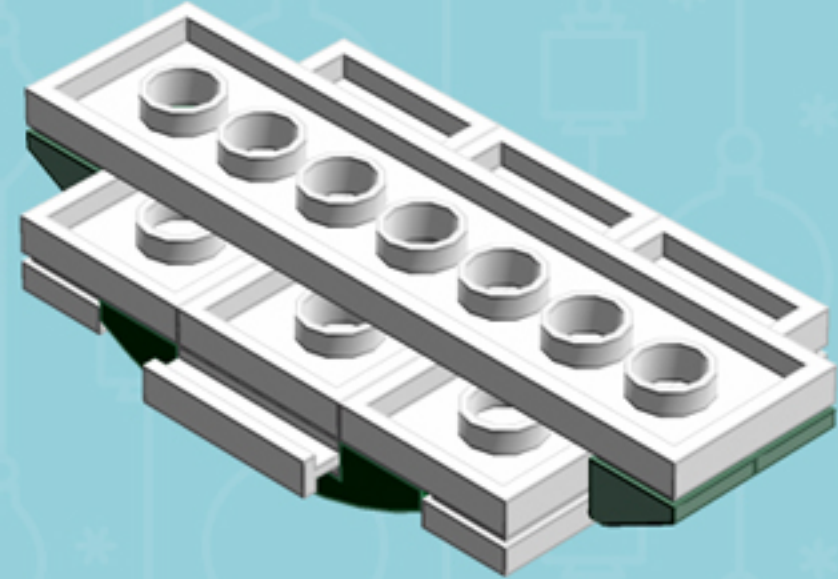
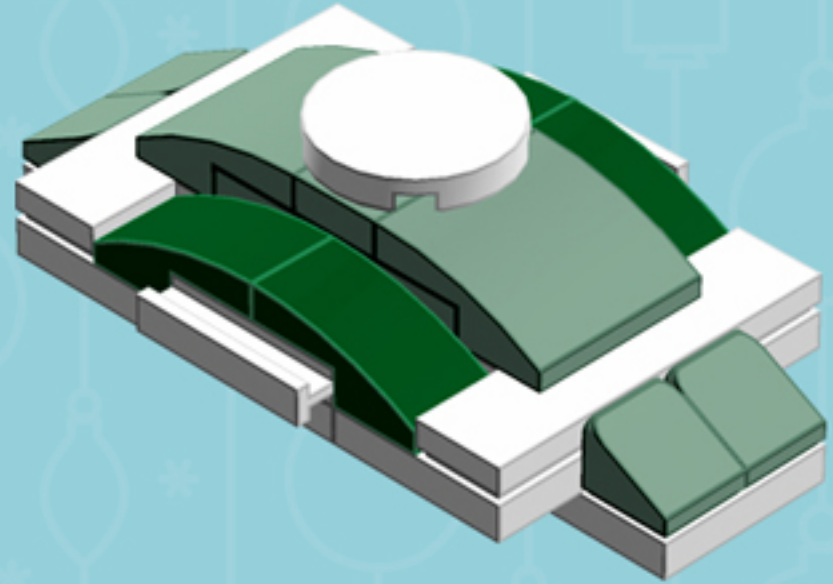

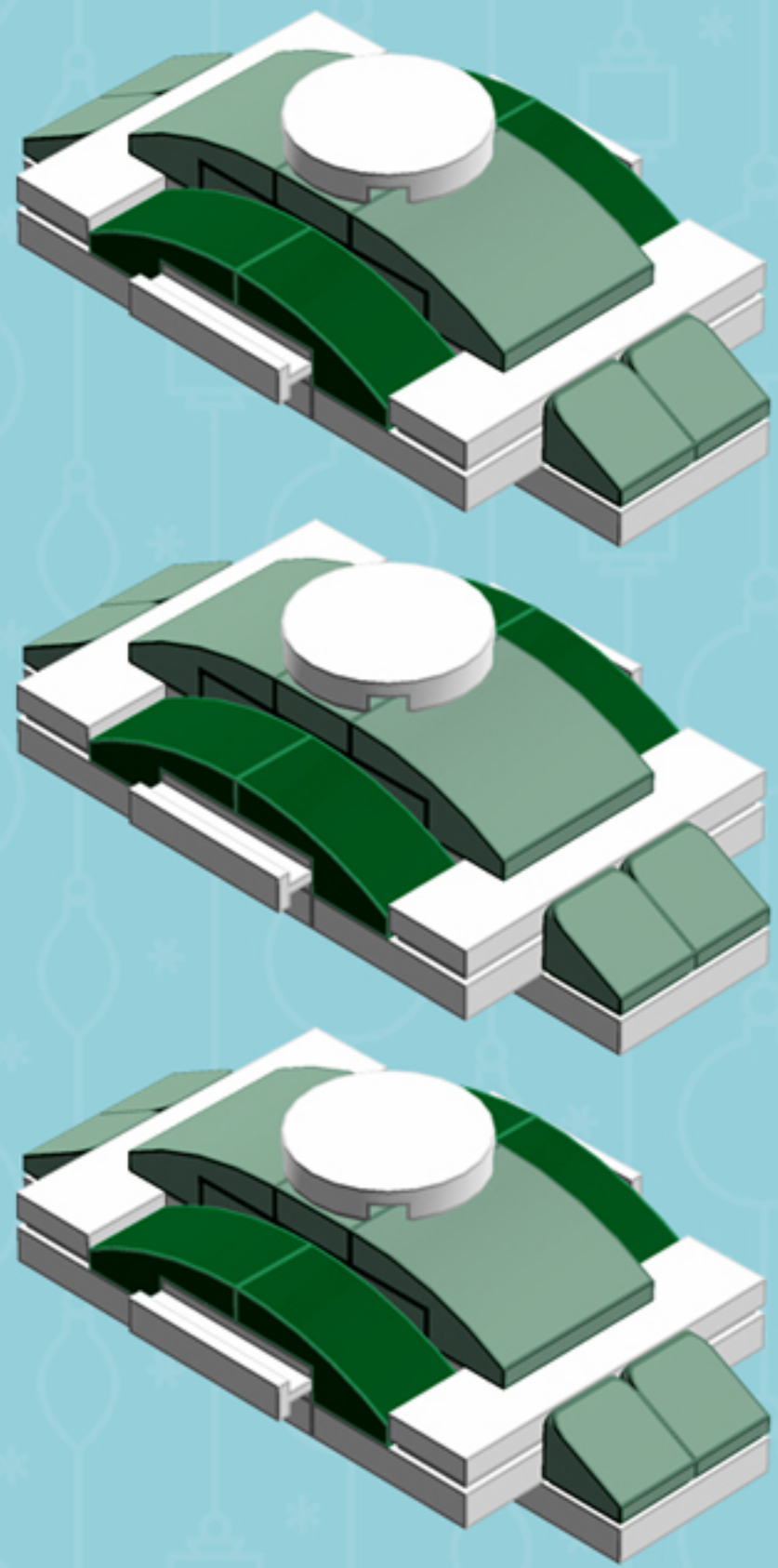

3x

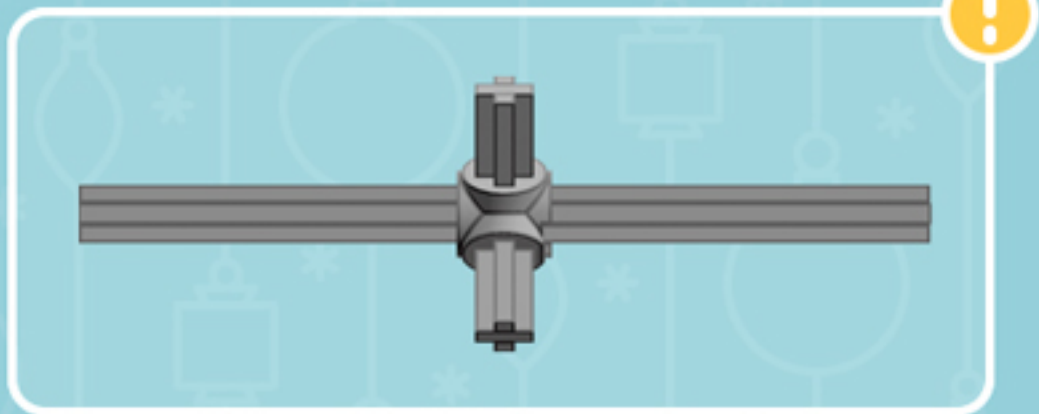



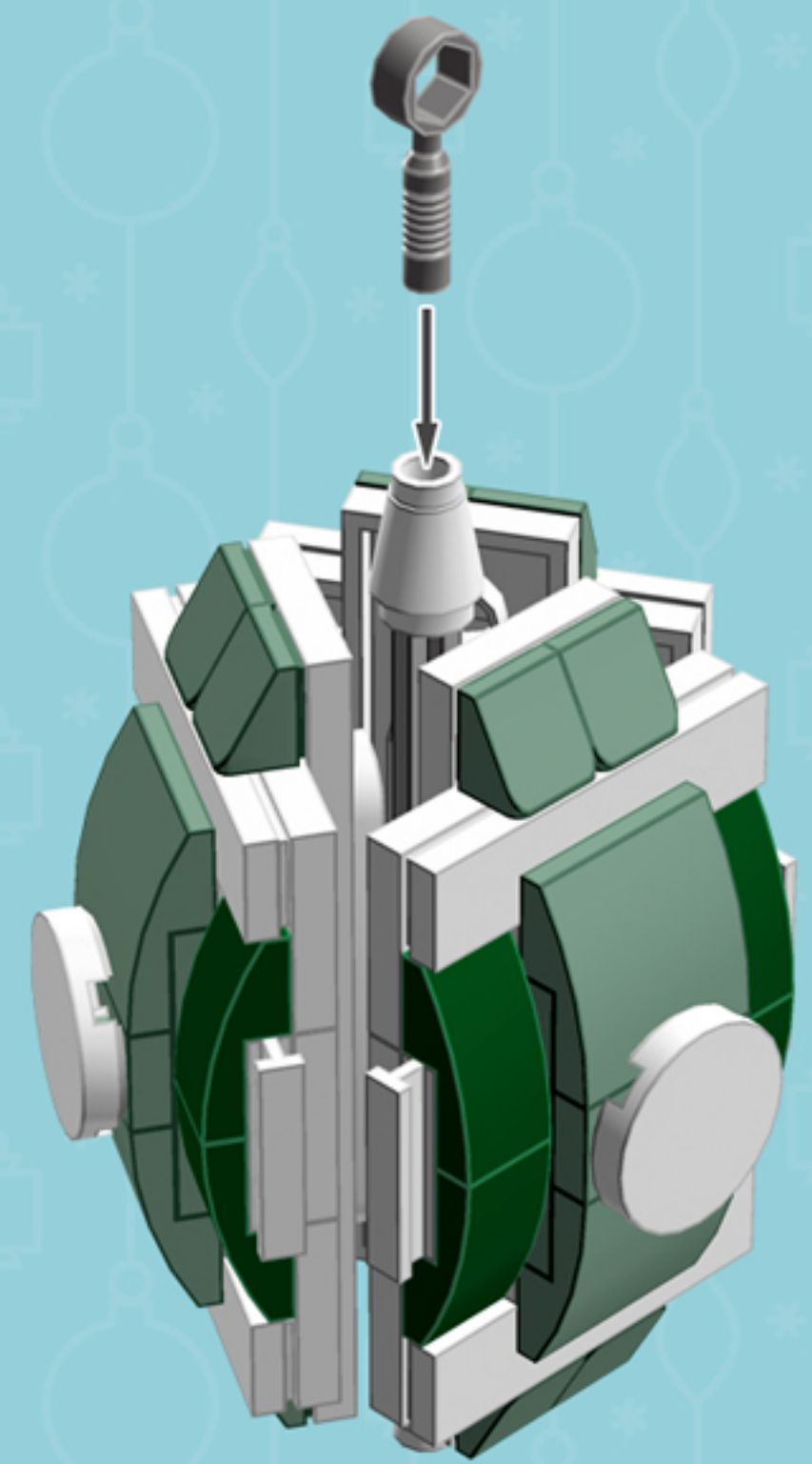
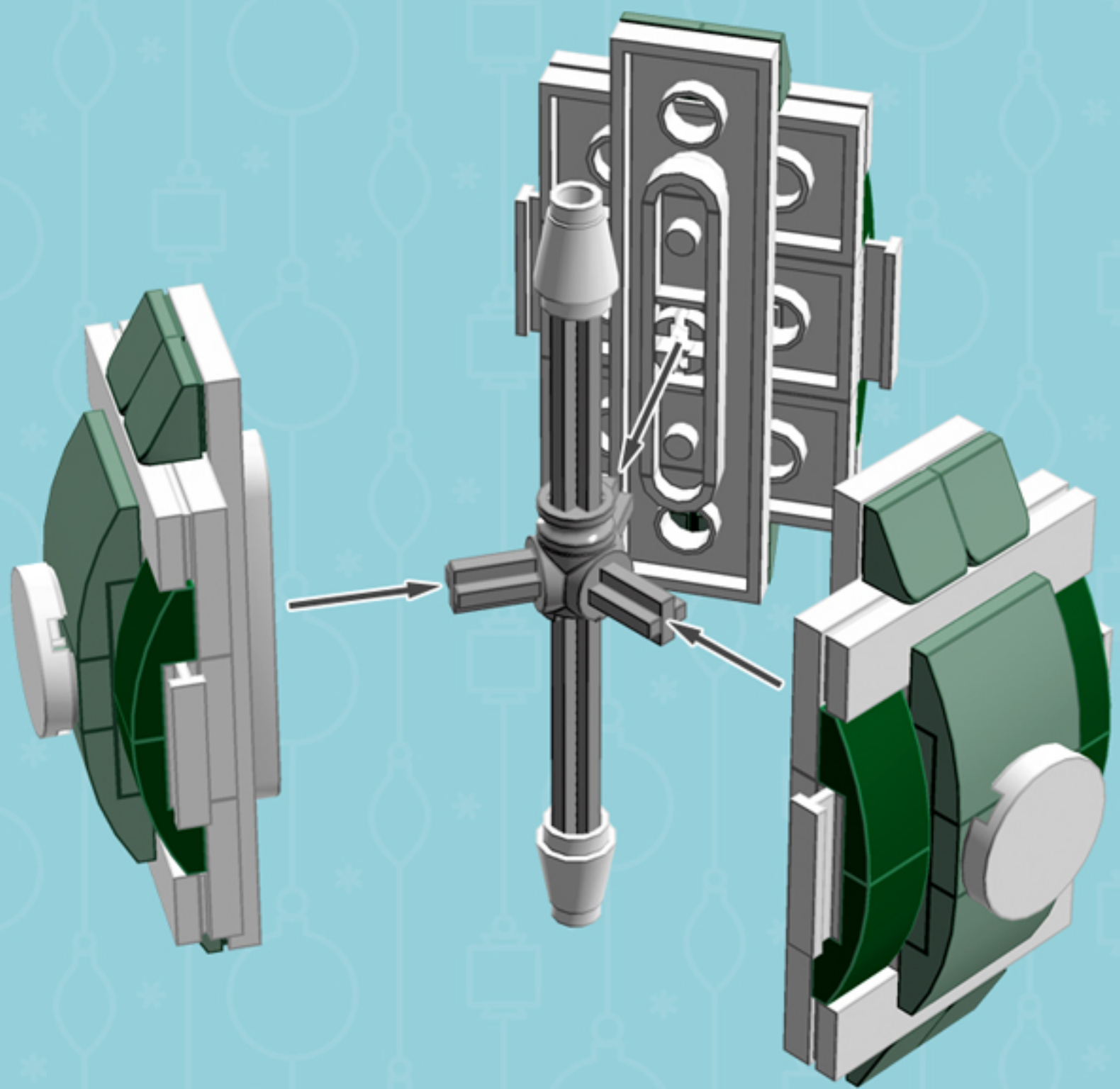



*For more fun builds,  
please pop by [chrismcveigh.com](http://chrismcveigh.com),  
visit me at [facebook.com/c.mcveigh.photos](https://facebook.com/c.mcveigh.photos),  
or follow me on twitter [@actionfigured](https://twitter.com/actionfigured)*

*Purchase custom building kits at [shop.chrismcveigh.com](http://shop.chrismcveigh.com)*

*These building guides are for personal use only. Unauthorized duplication, distribution and/or modification of these guides, in whole or in part, is strictly prohibited. The models contained within these guides are the copyright of Chris McVeigh, unless otherwise stated. Unauthorized reproduction of these models for resale, either in whole or as a building kit, is strictly prohibited.*

*© 2015 CHRIS MCVEIGH*

*LEGO is a registered trademark of The LEGO Group.*