

Cooper

ORNAMENT

A LEGO® project by Chris McVeigh
chrismcveigh.com

• CHOCOLATE •

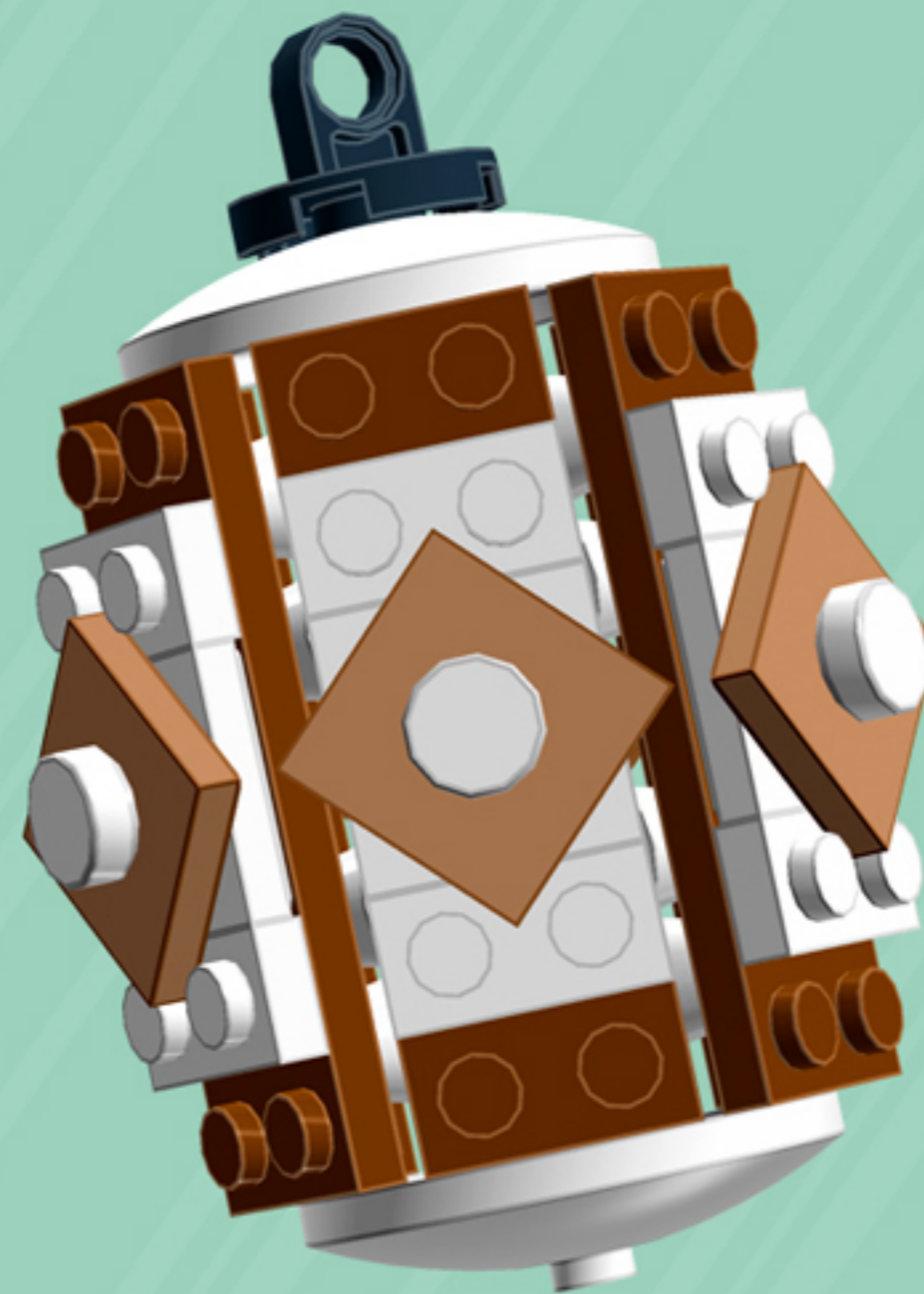



Element ID	Color	Description	Quantity
6010831	Black	Round Plate 2X2 W/Eye	1
6102994	Medium Nougat	Plate 2X2 W 1 Knob	6
4502595	Medium Stone Grey	3-Branch Cross Axle W/Cross H.	4
4211622	Medium Stone Grey	Bush For Cross Axle	1
4211805	Medium Stone Grey	Cross Axle 7M	1
4211247	Reddish Brown	Plate 2X6	6
4646844	White	Flat Tile 1X1, Round	6
4518400	White	Nose Cone Small 1X1	12
302301	White	Plate 1X2	12
403201	White	Plate 2X2 Round	2
4565324	White	Plate 2X2 W 1 Knob	6
396001	White	Round Plate Ø32X6.4	2



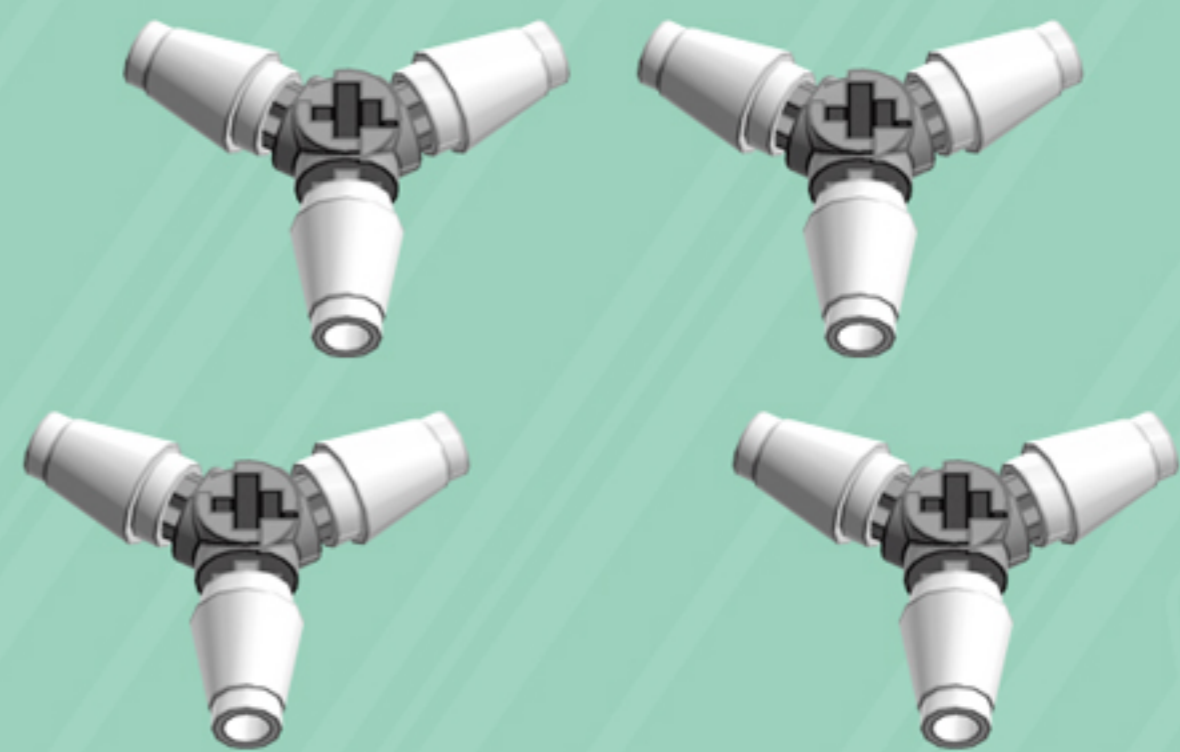
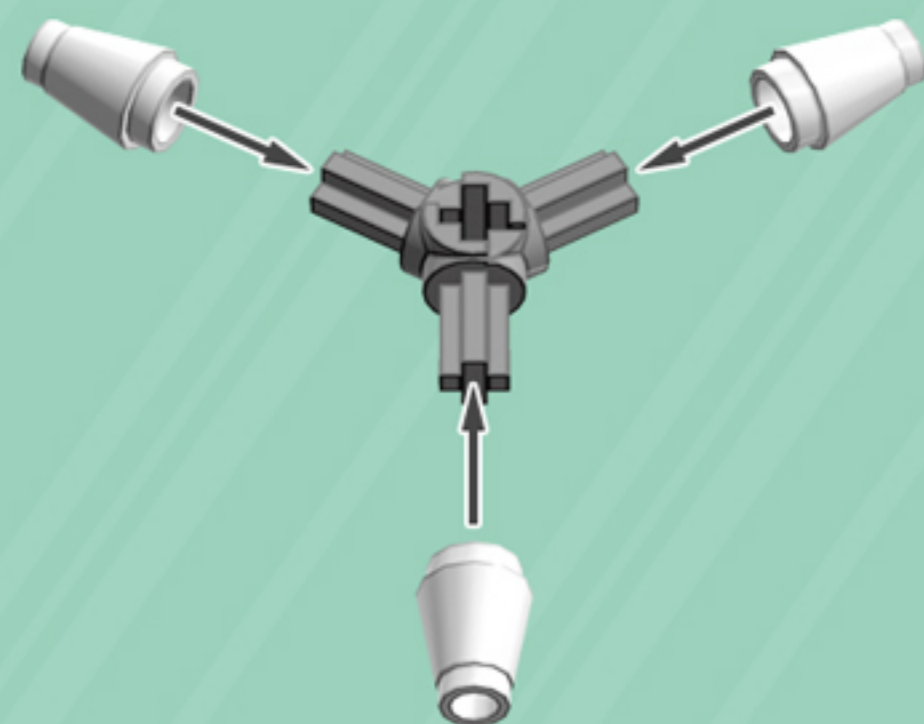
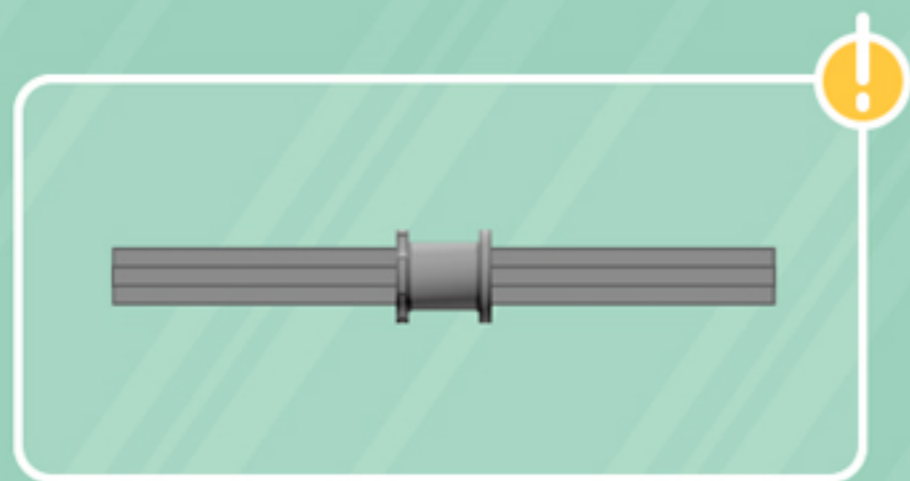

4x

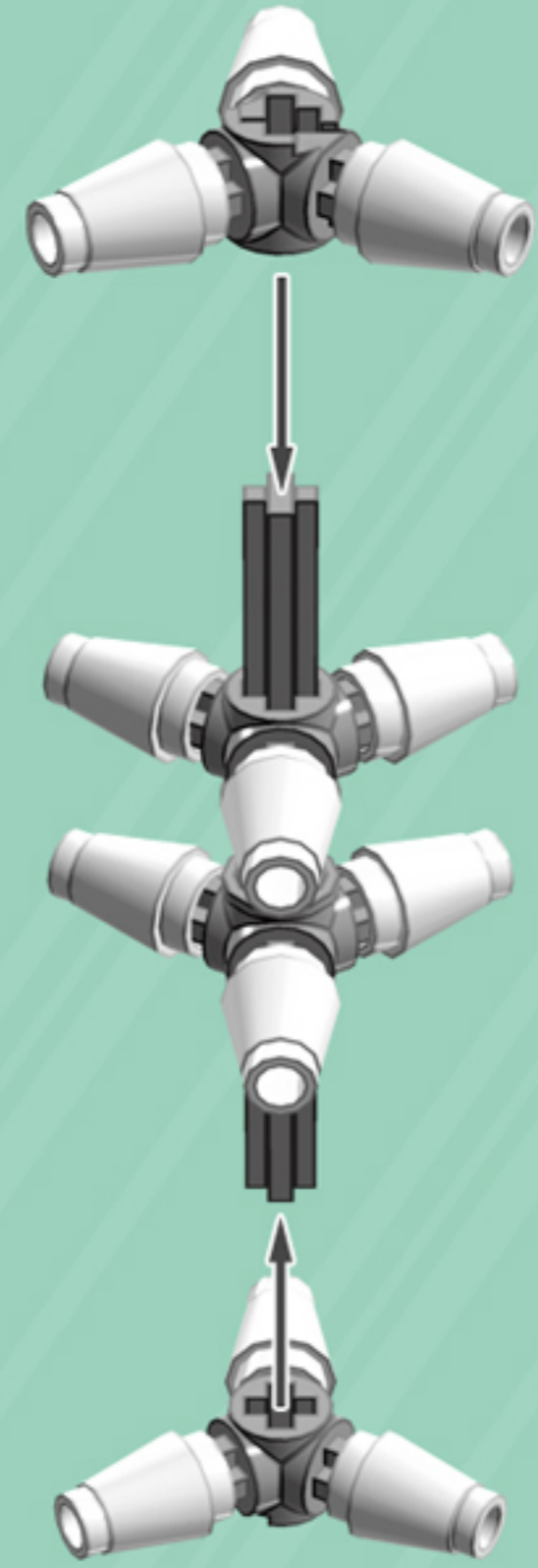
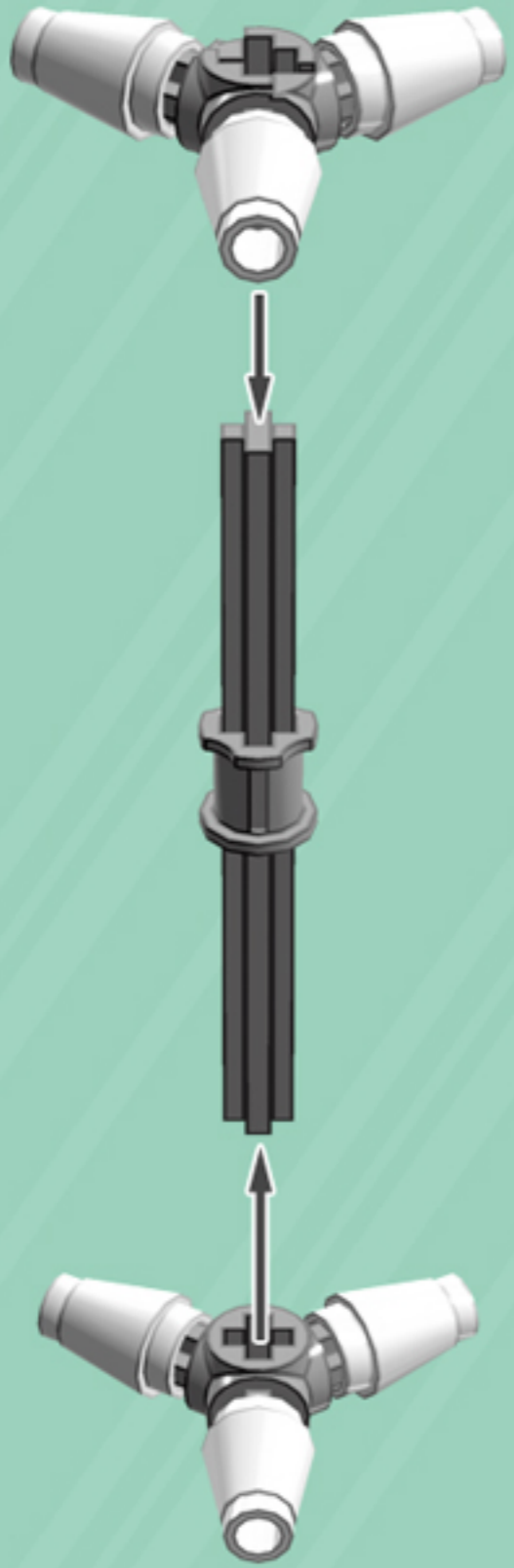

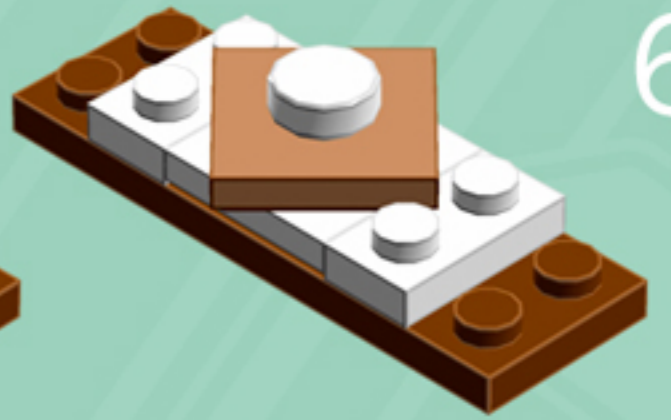
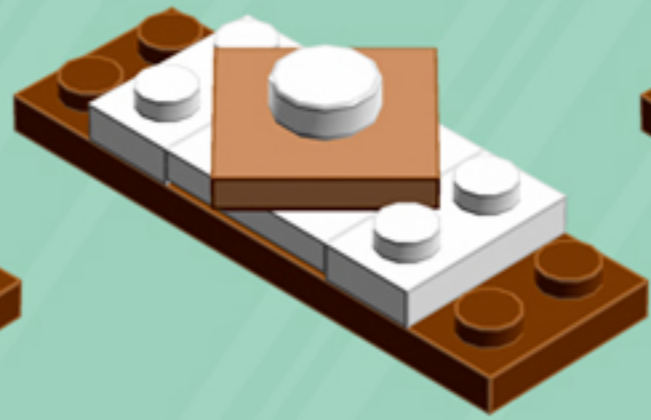
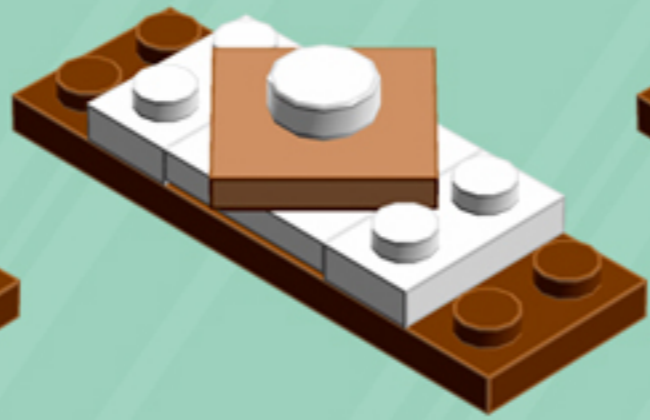
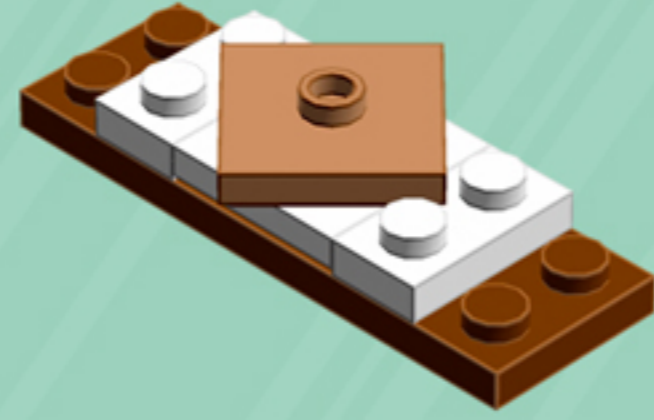
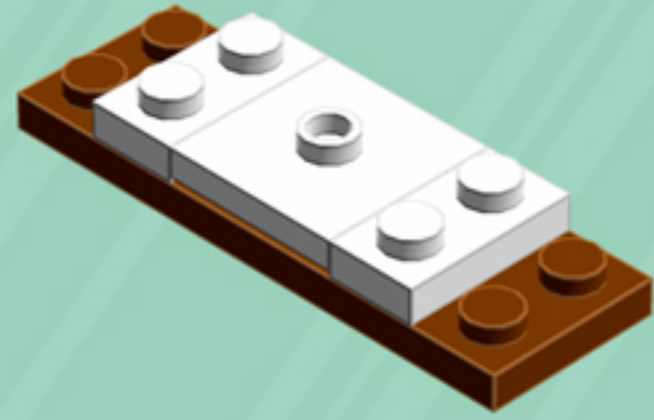

6x

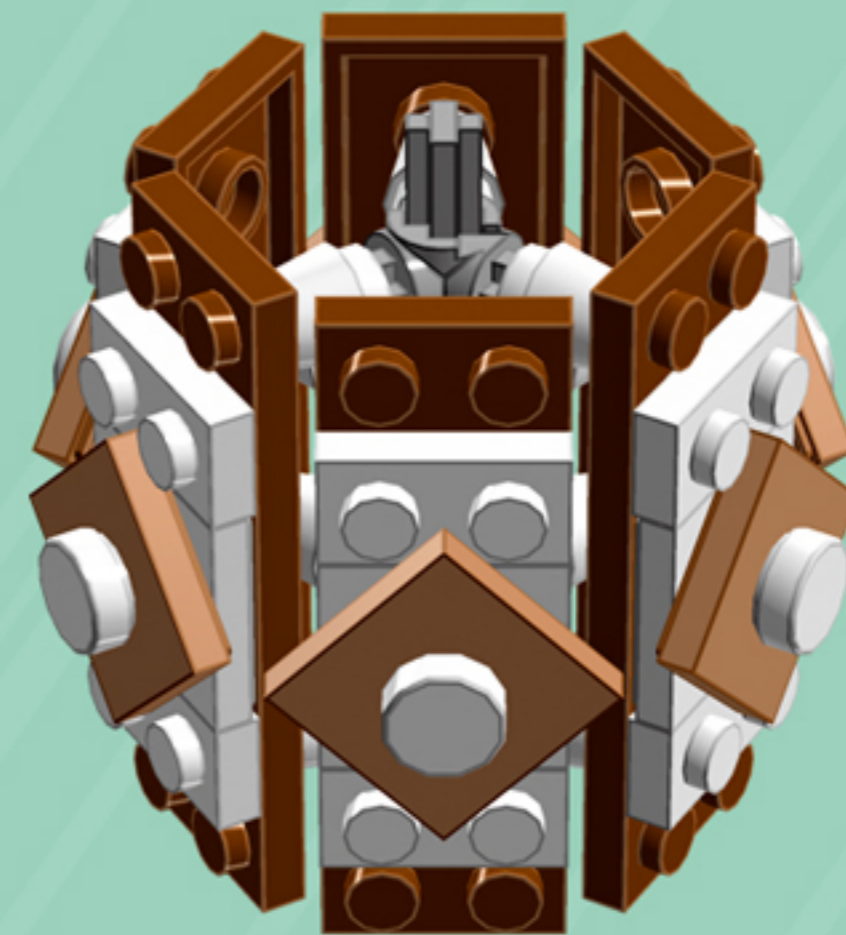
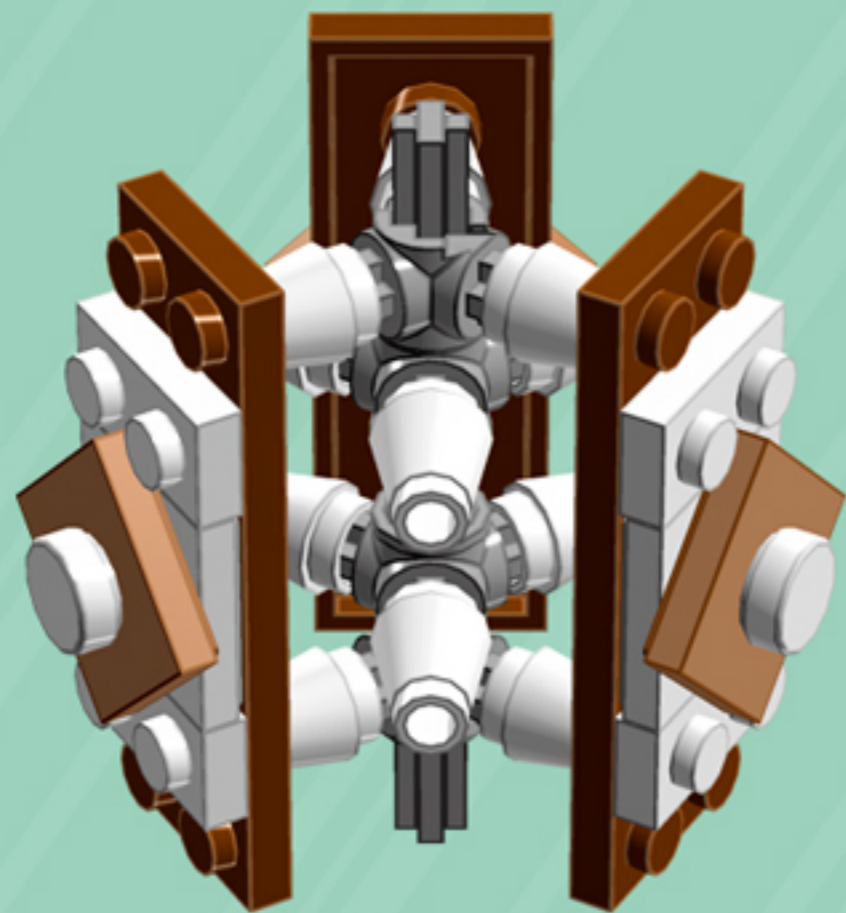
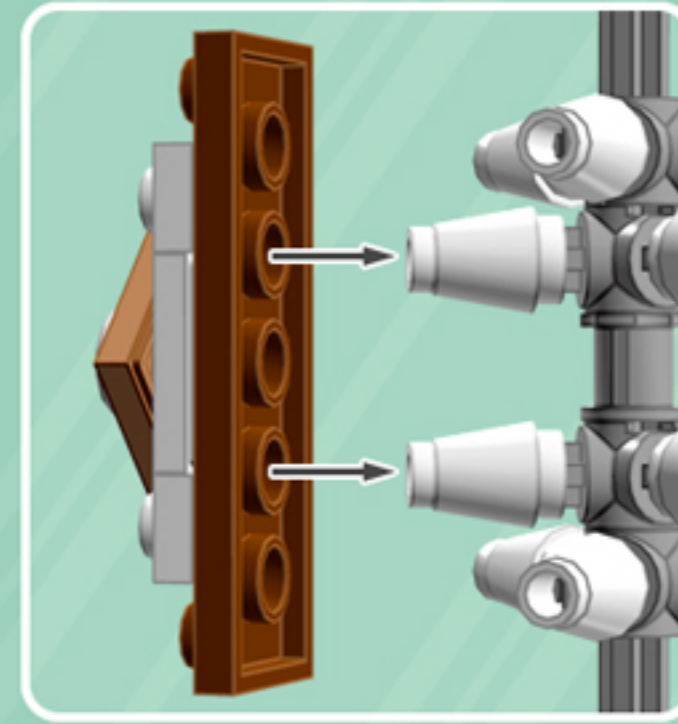
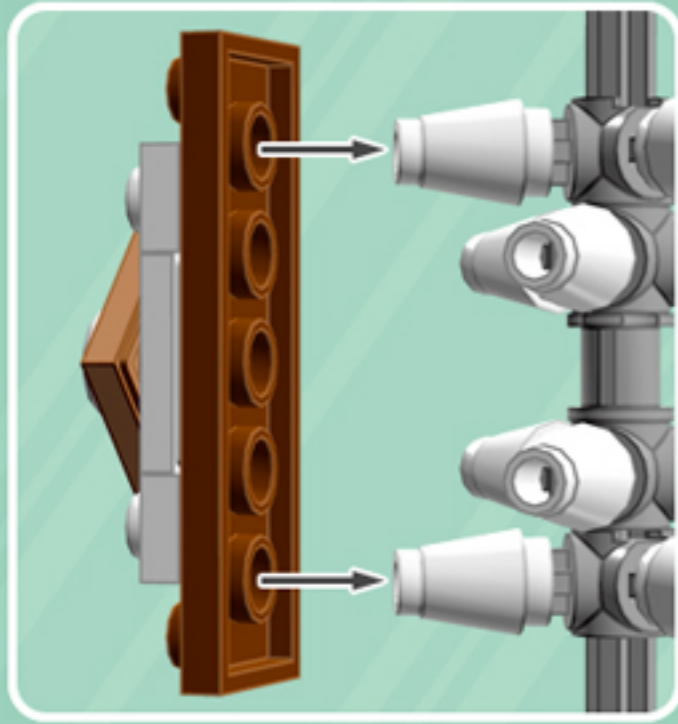

3x

3x

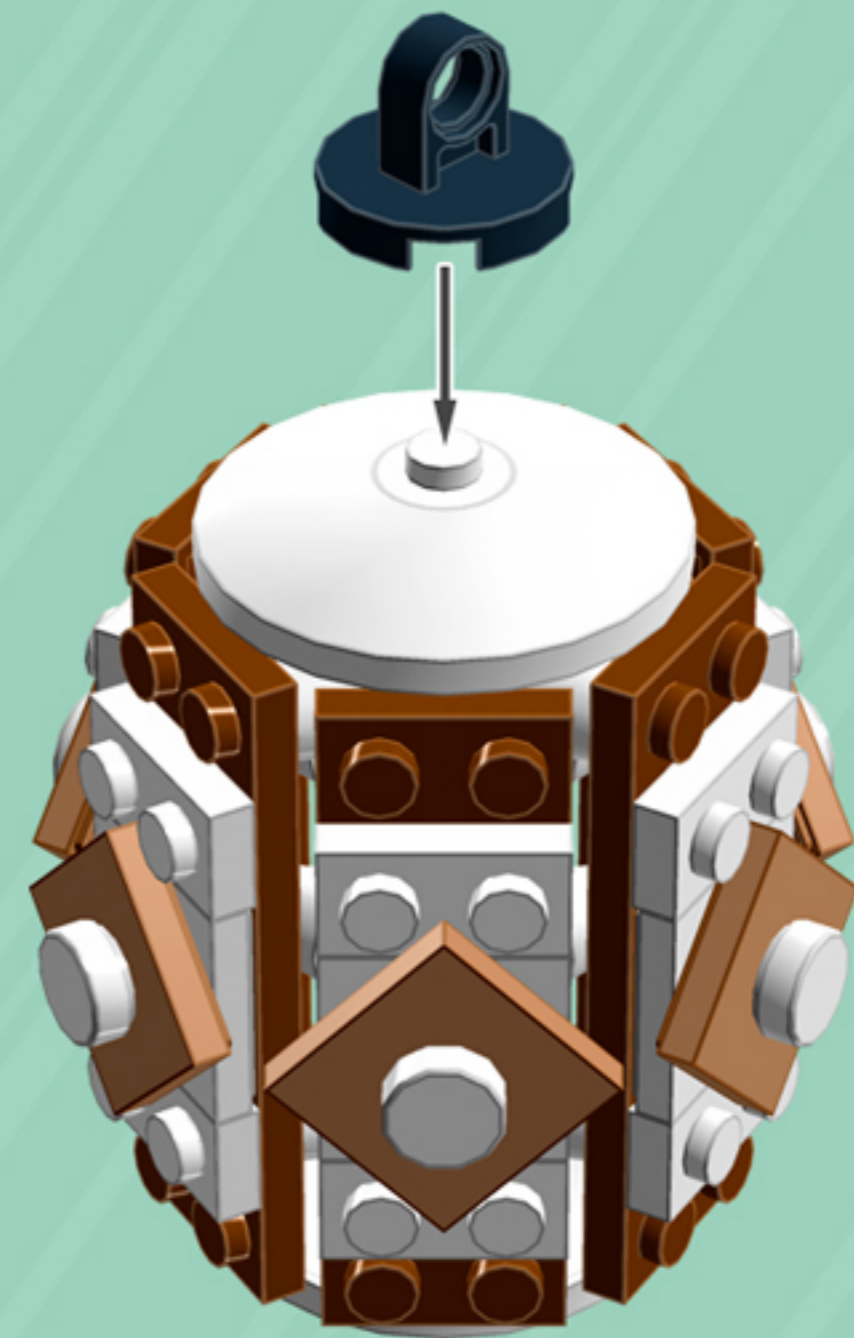
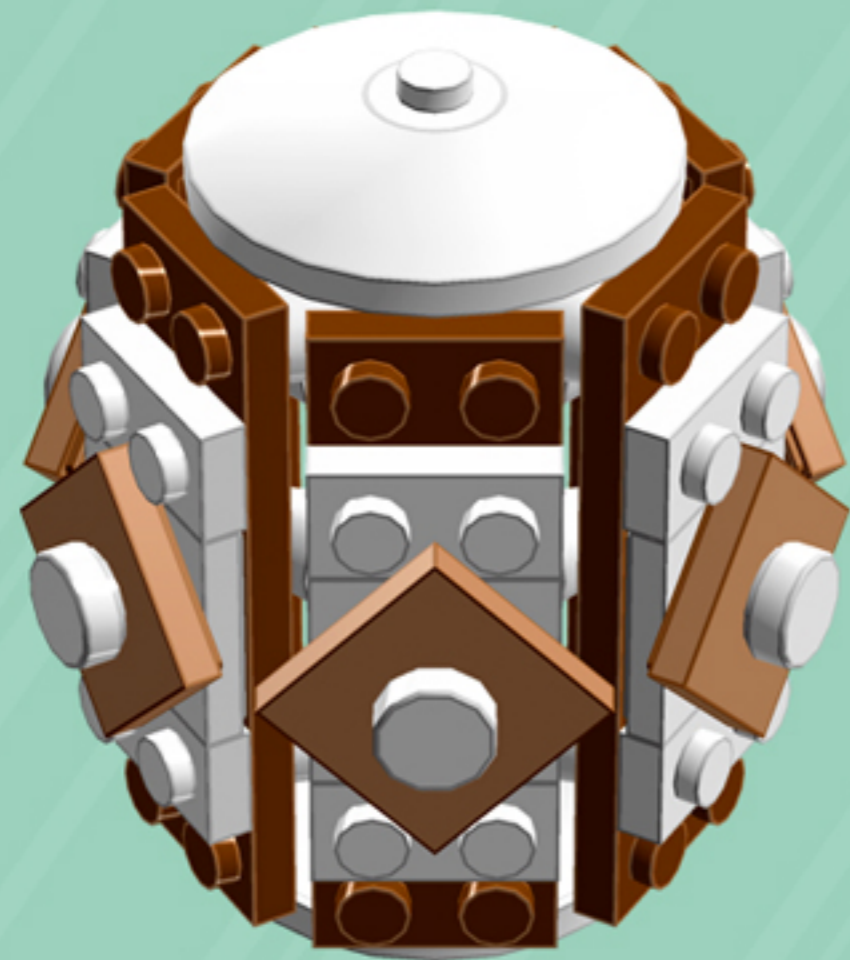

*For more fun builds,
please stop by chrismcveigh.com,
visit me at facebook.com/c.mcveigh.photos,
or follow me on twitter [@actionfigured](https://twitter.com/actionfigured)*

Purchase custom building kits at shop.chrismcveigh.com

These building guides are for personal use only. Unauthorized duplication, distribution and/or modification of these guides, in whole or in part, is strictly prohibited. The models contained within these guides are the copyright of Chris McVeigh, unless otherwise stated. Unauthorized reproduction of these models for resale, either in whole or as a building kit, is strictly prohibited.

© 2016 CHRIS MCVEIGH

LEGO is a registered trademark of The LEGO Group.

