

# Cooper

ORNAMENT

*A LEGO® project by Chris McVeigh*  
*[chrismcveigh.com](http://chrismcveigh.com)*



• MERRY MULBERRY •

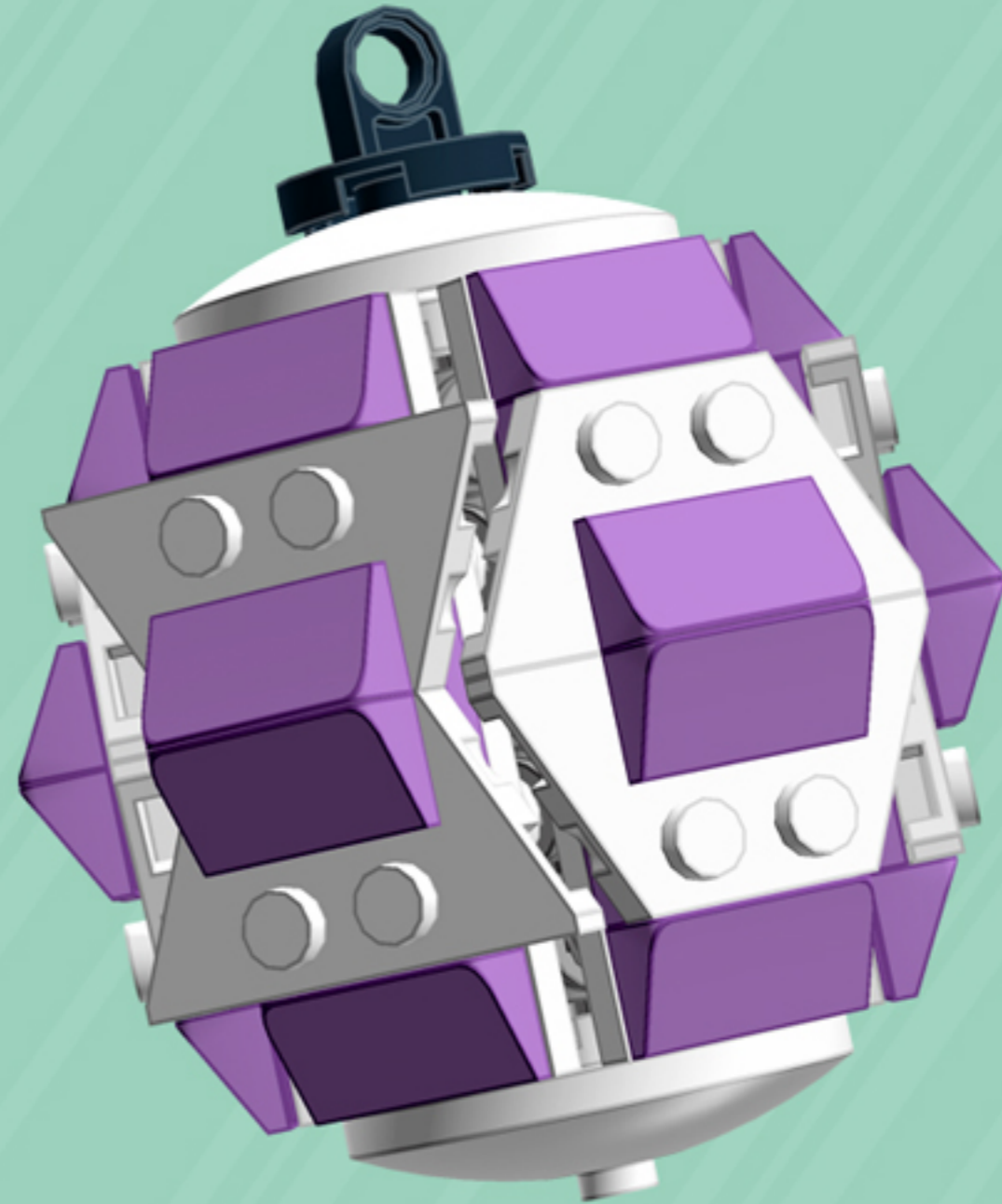



Element ID	Color	Description	Quantity
6010831	Black	Round Plate 2X2 W/Eye	1
4619516	Medium Lavender	Plate 2X4	6
4625024	Medium Lavender	Roof Tile 1X2X2/3, Abs	24
4502595	Medium Stone Grey	3-Branch Cross Axle W/Cross H.	4
4211622	Medium Stone Grey	Bush For Cross Axle	2
4211805	Medium Stone Grey	Cross Axle 7M	1
4518400	White	Nose Cone Small 1X1	12
403201	White	Plate 2X2 Round	2
4249506	White	Plate 2X4X18°	12
379501	White	Plate 2X6	6
396001	White	Round Plate Ø32X6.4	2



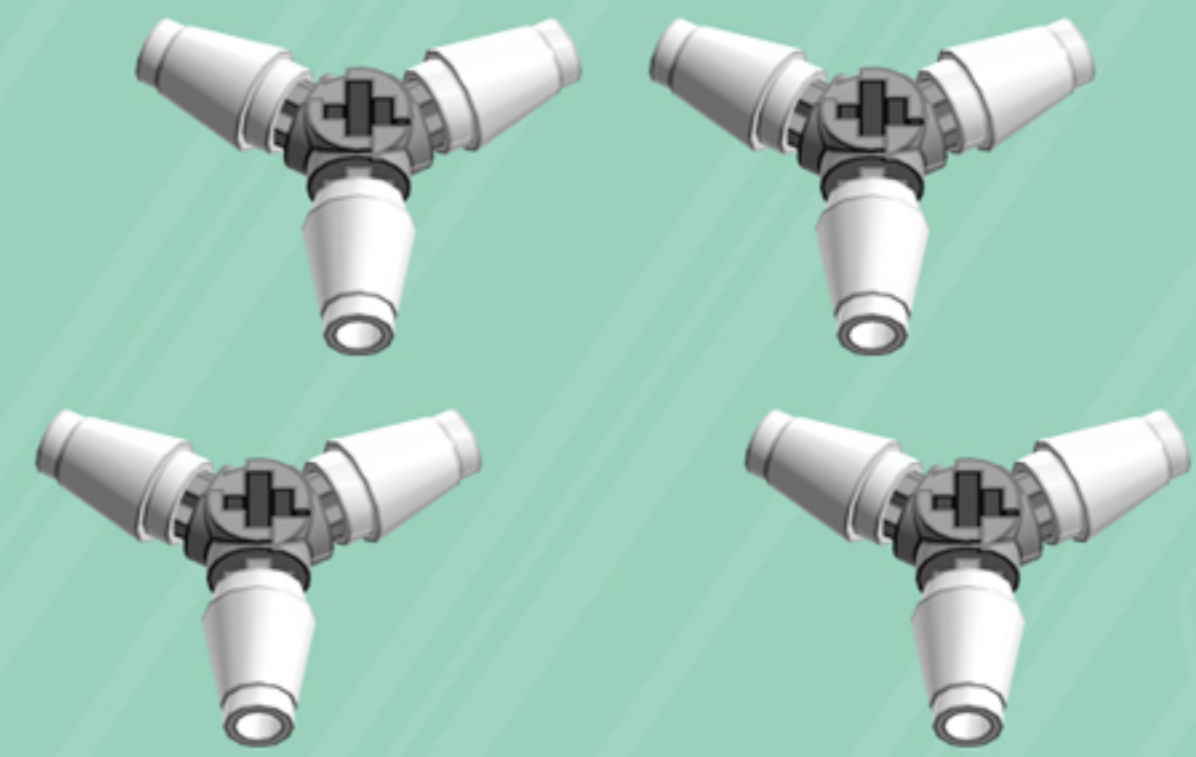
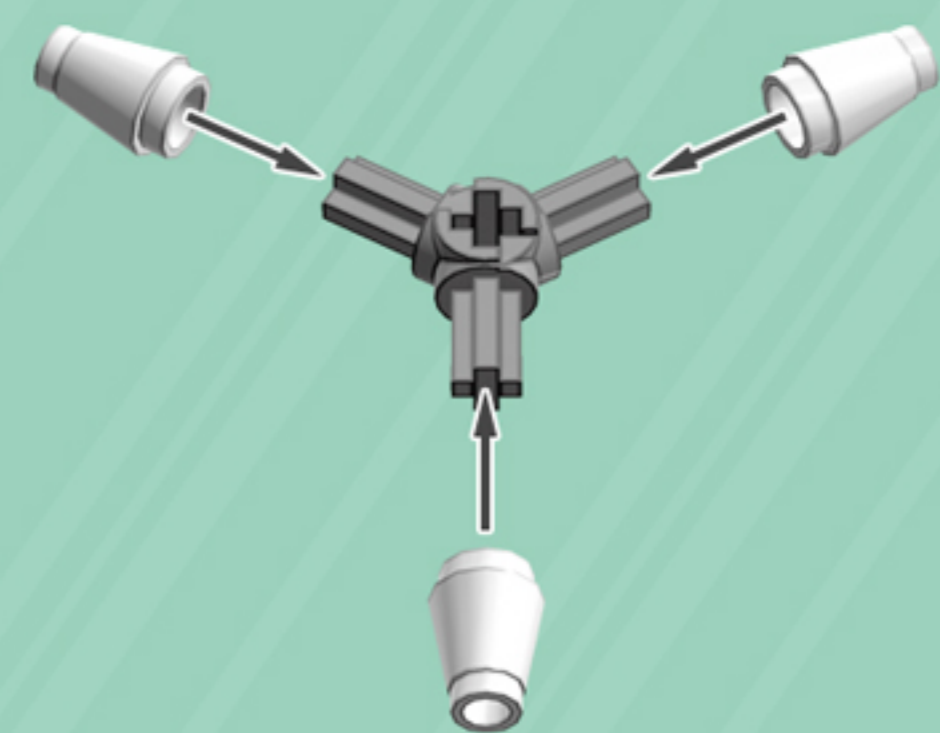
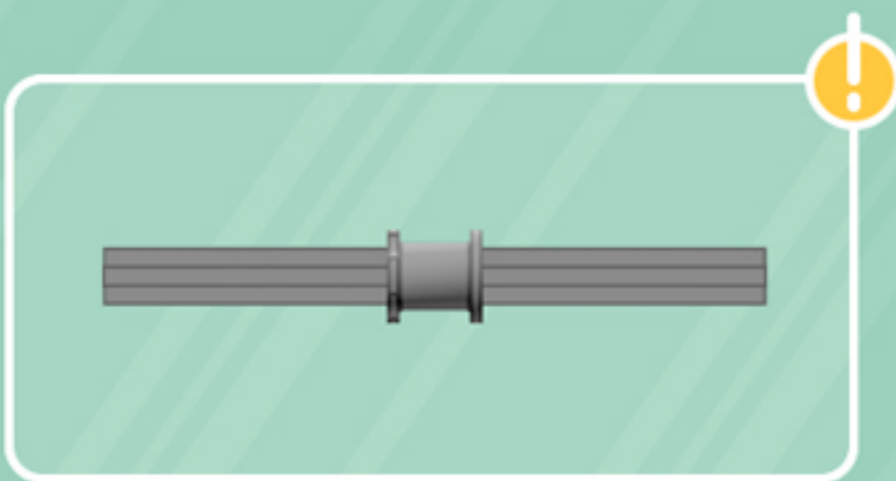

4x

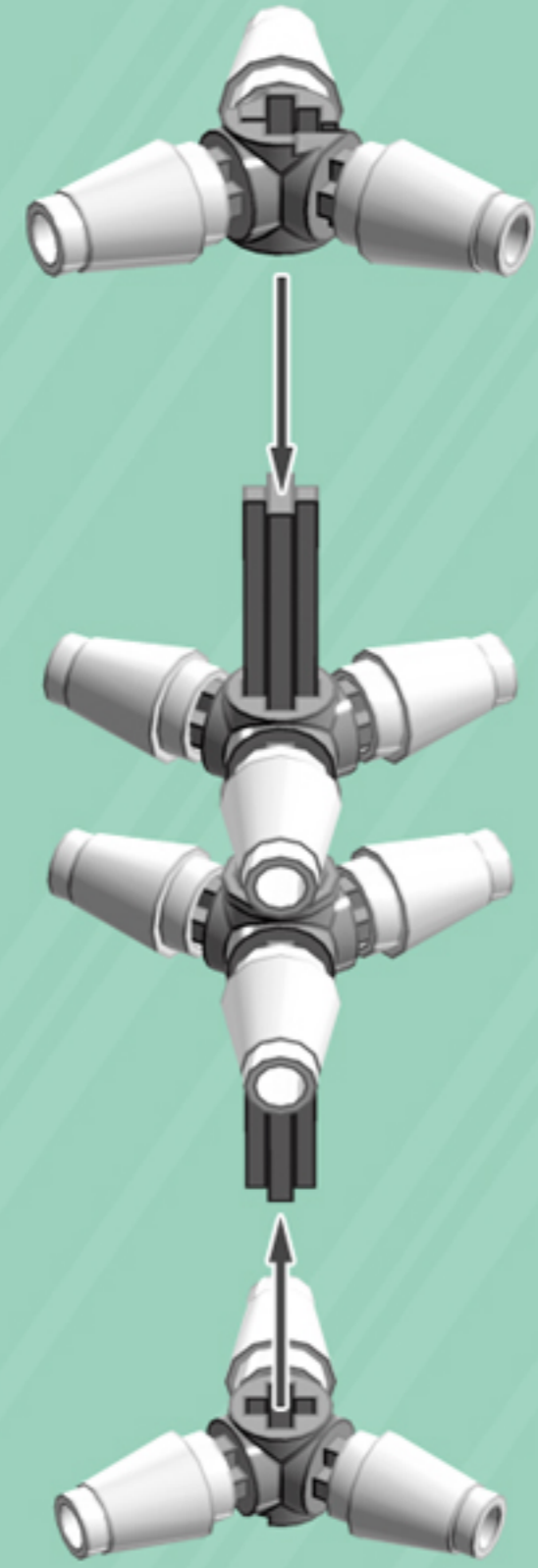
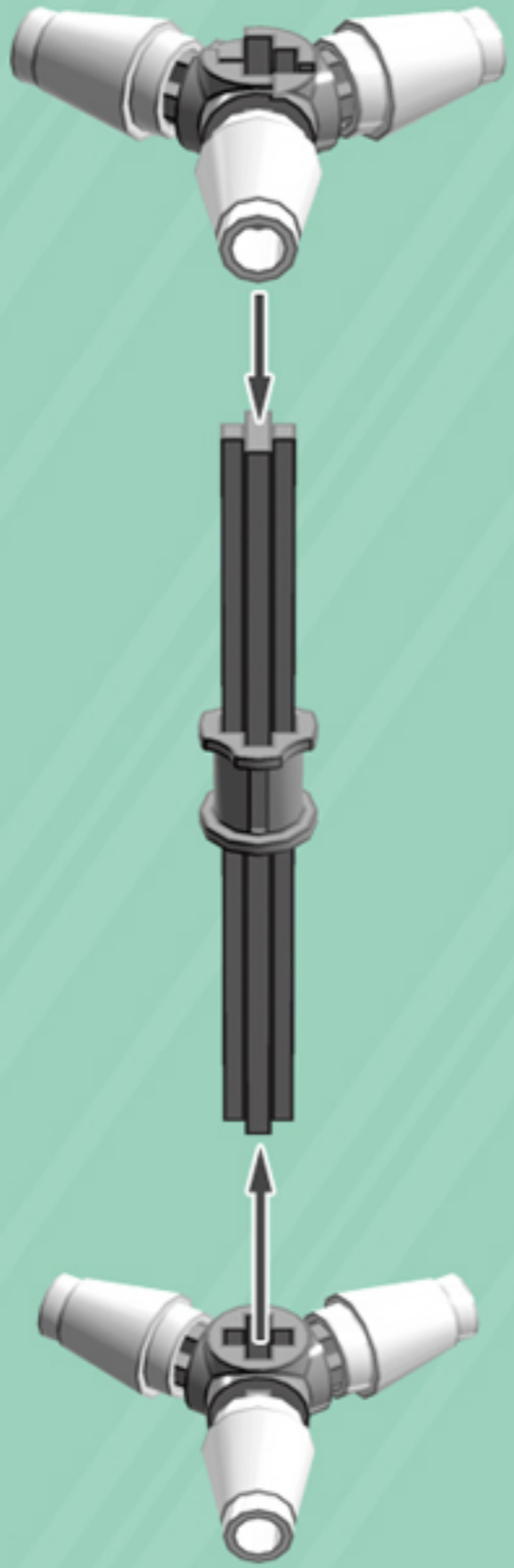





3x

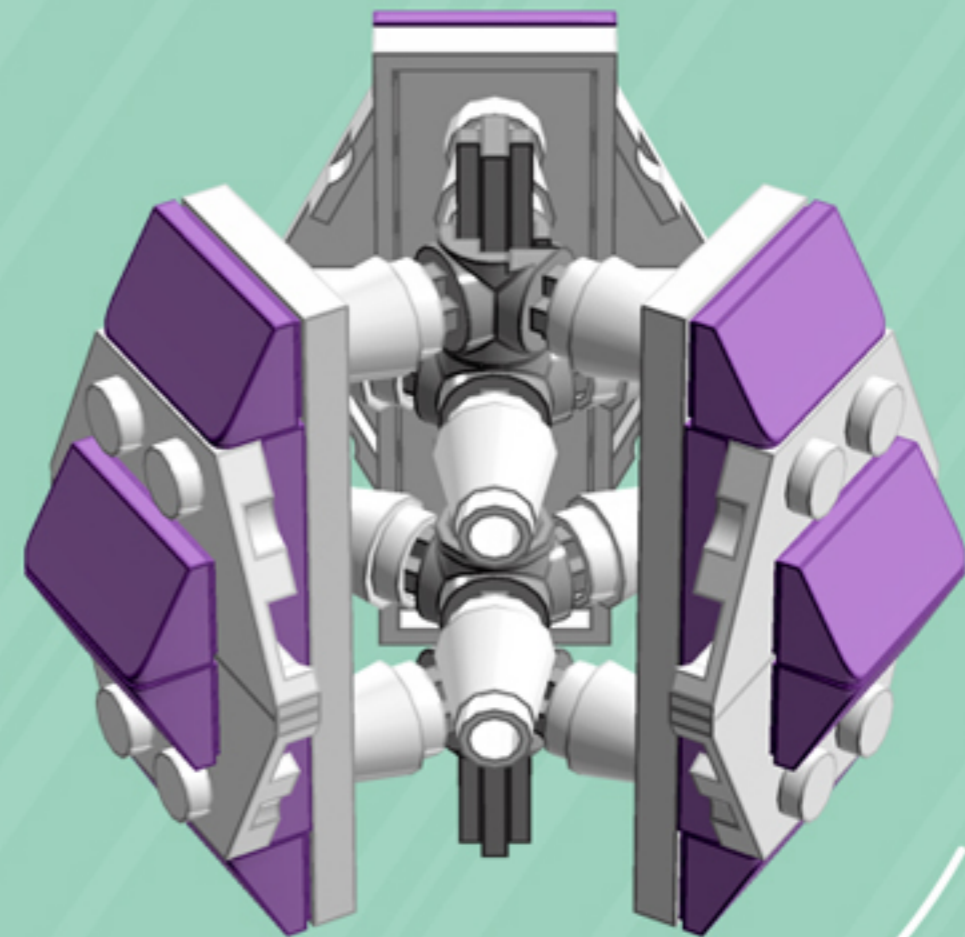
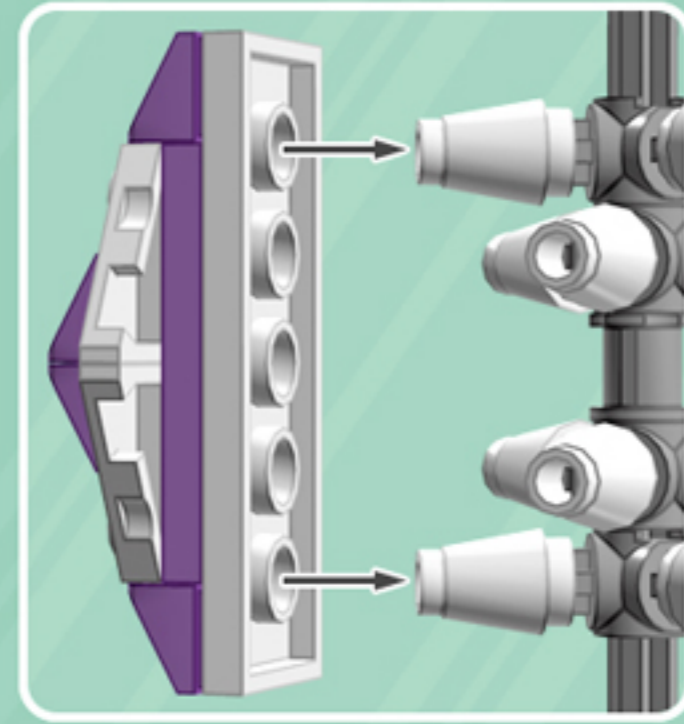

3x

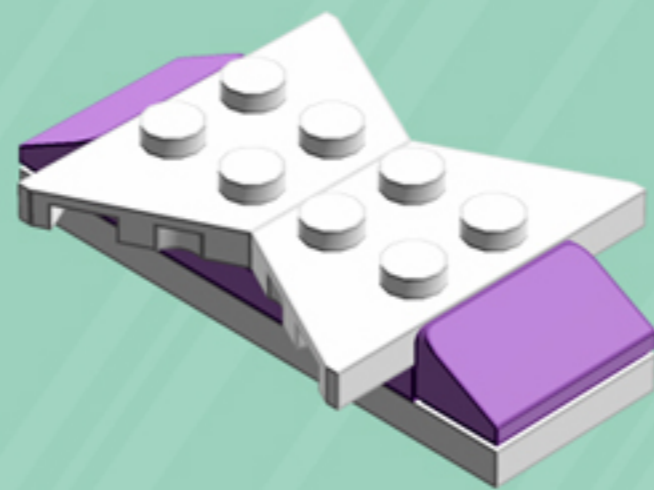

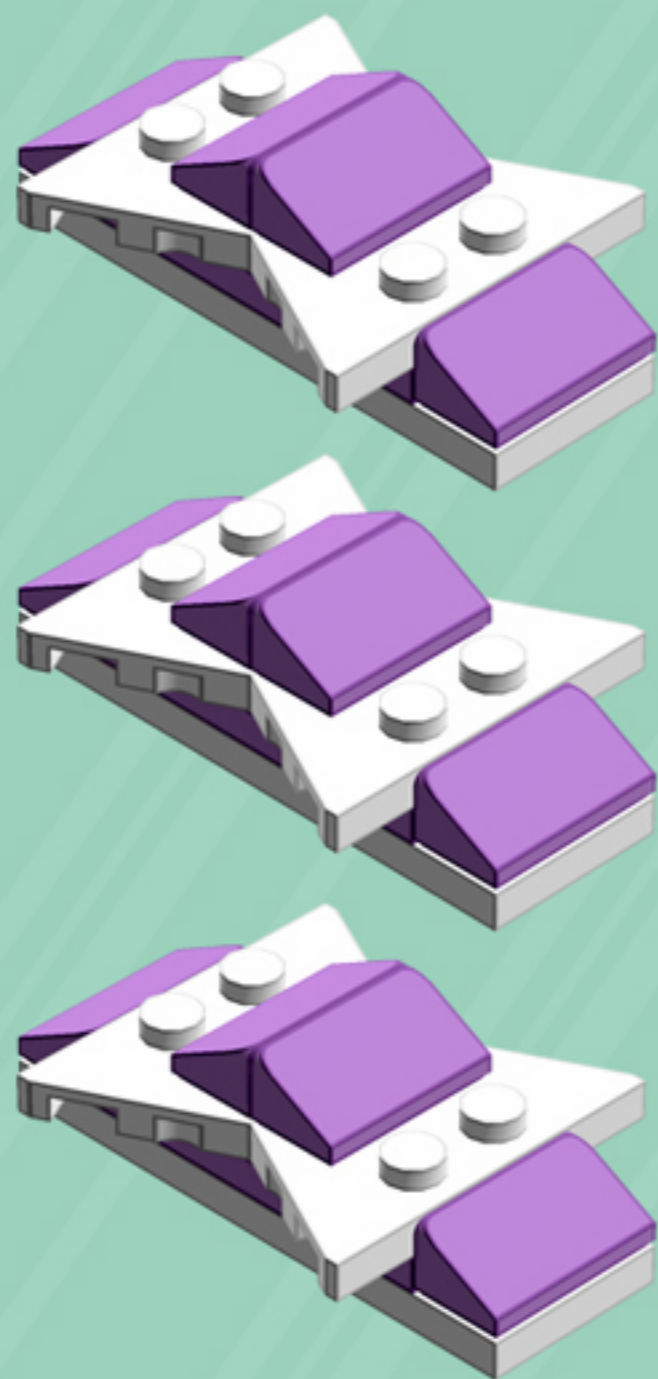

3x

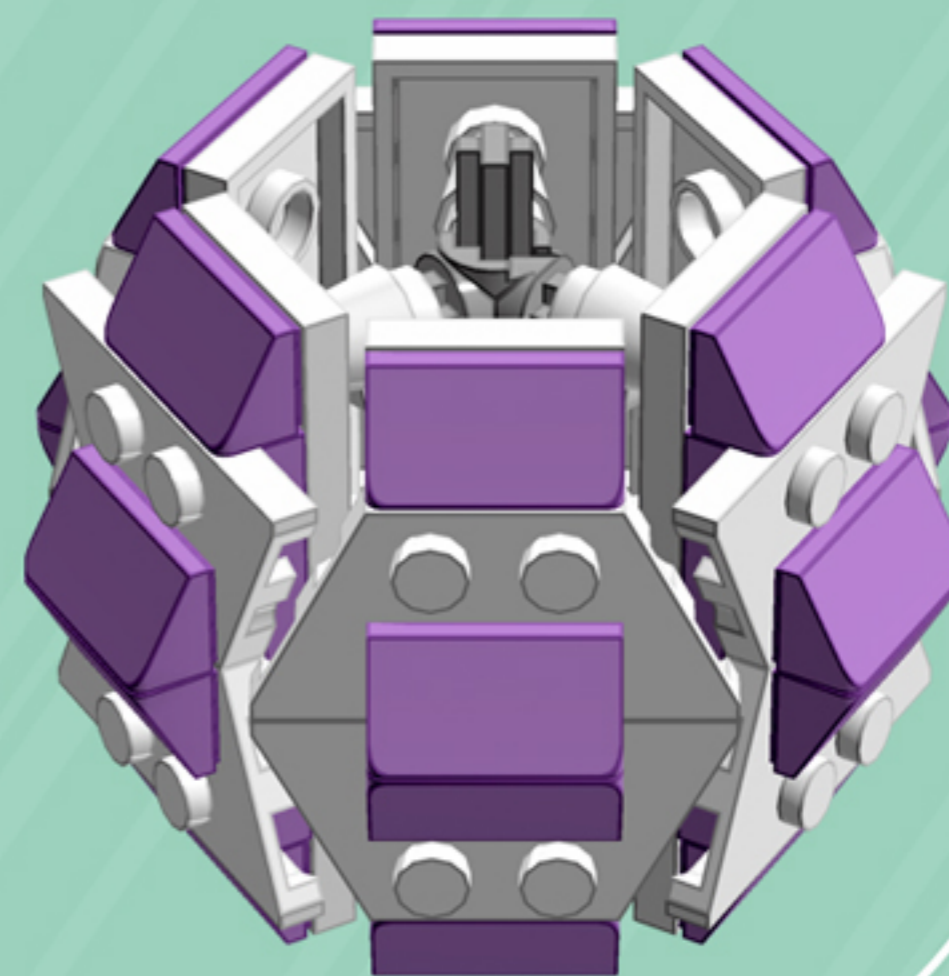
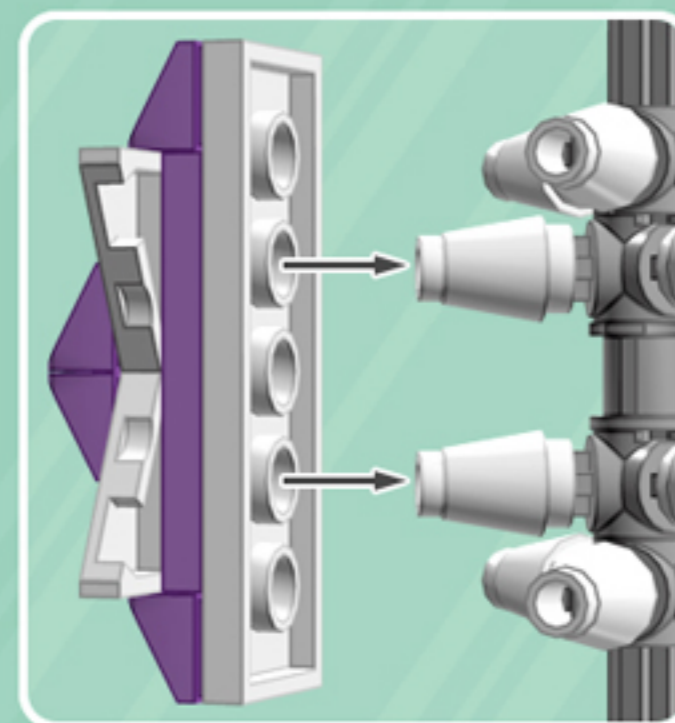

3x



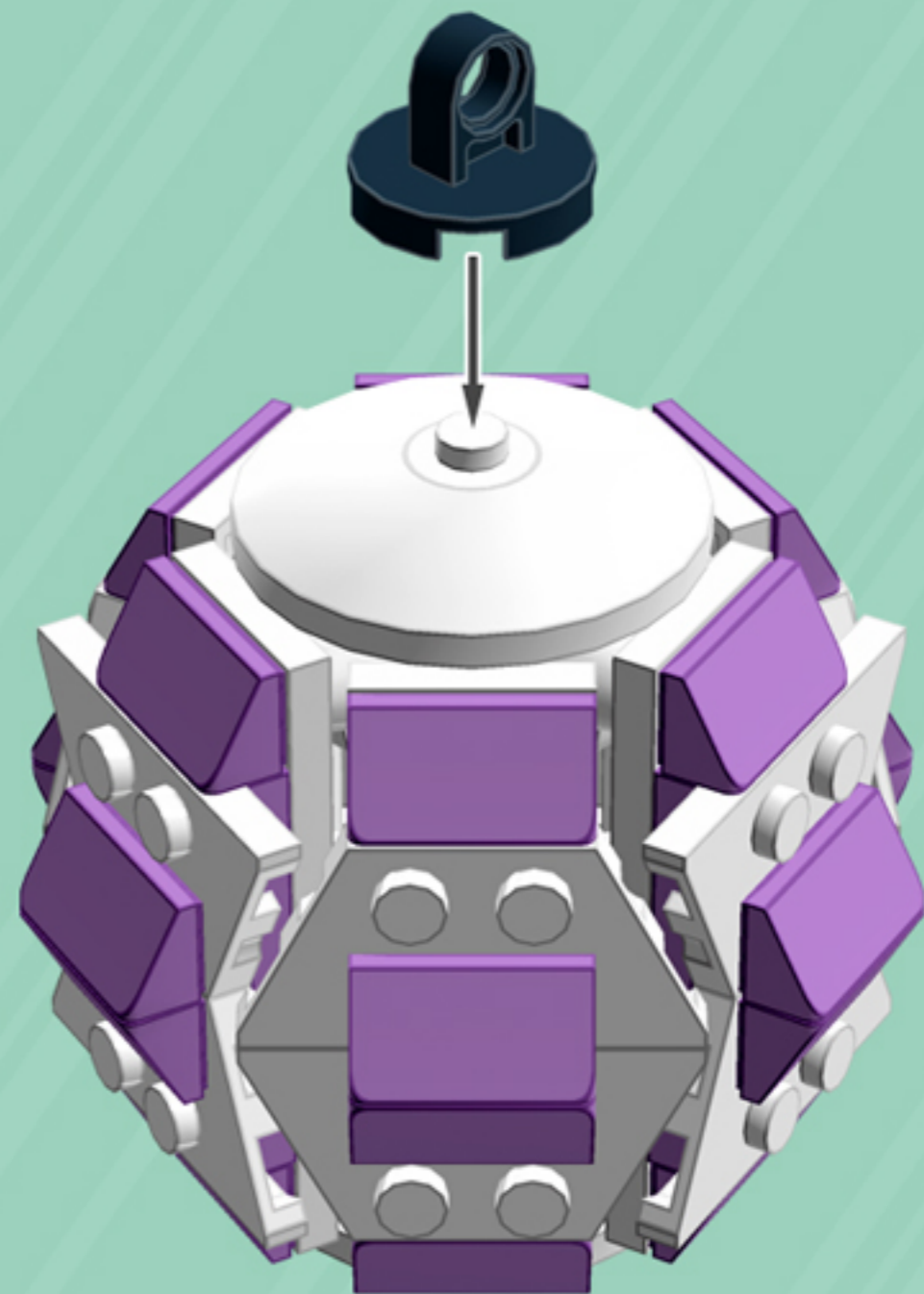
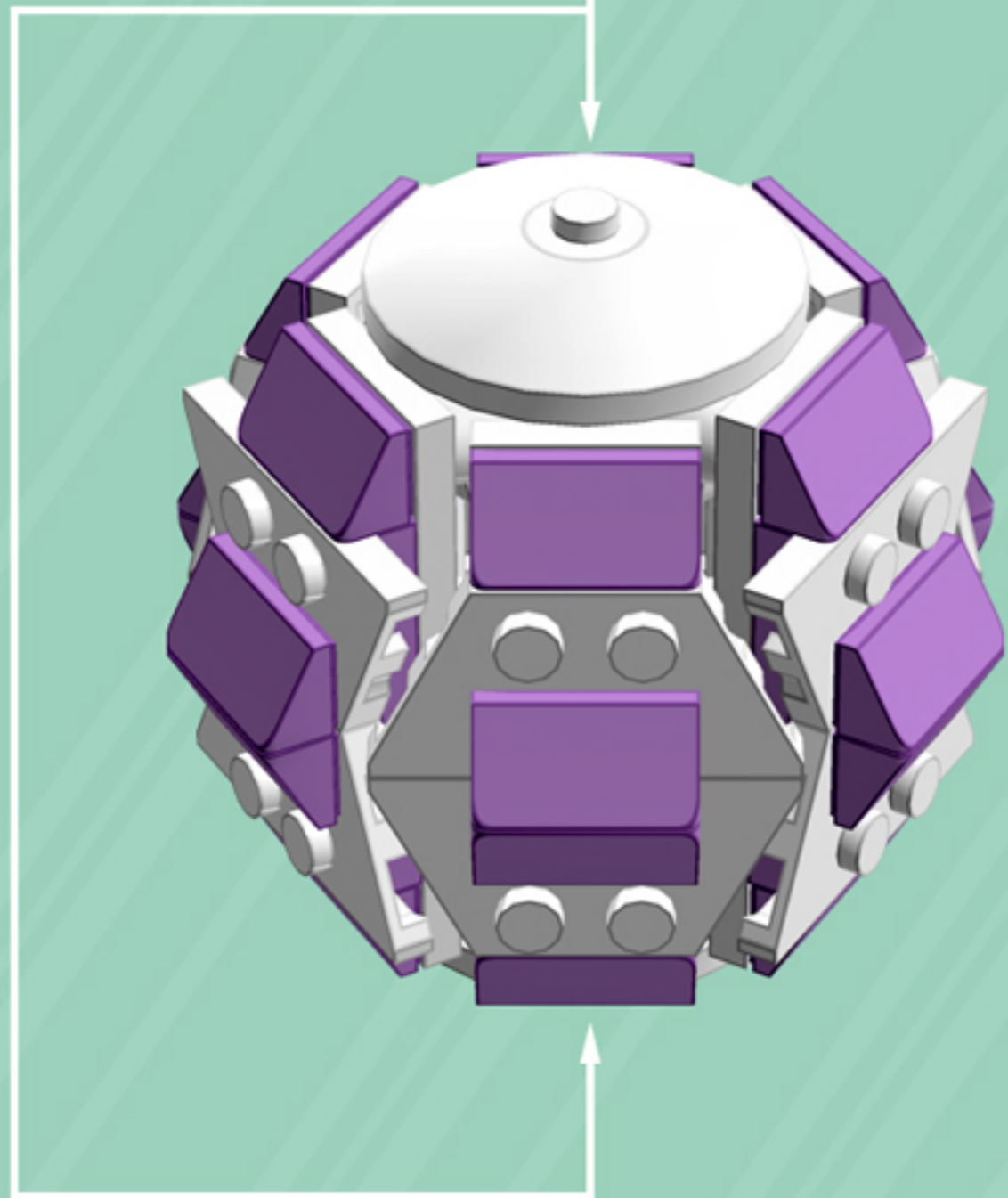

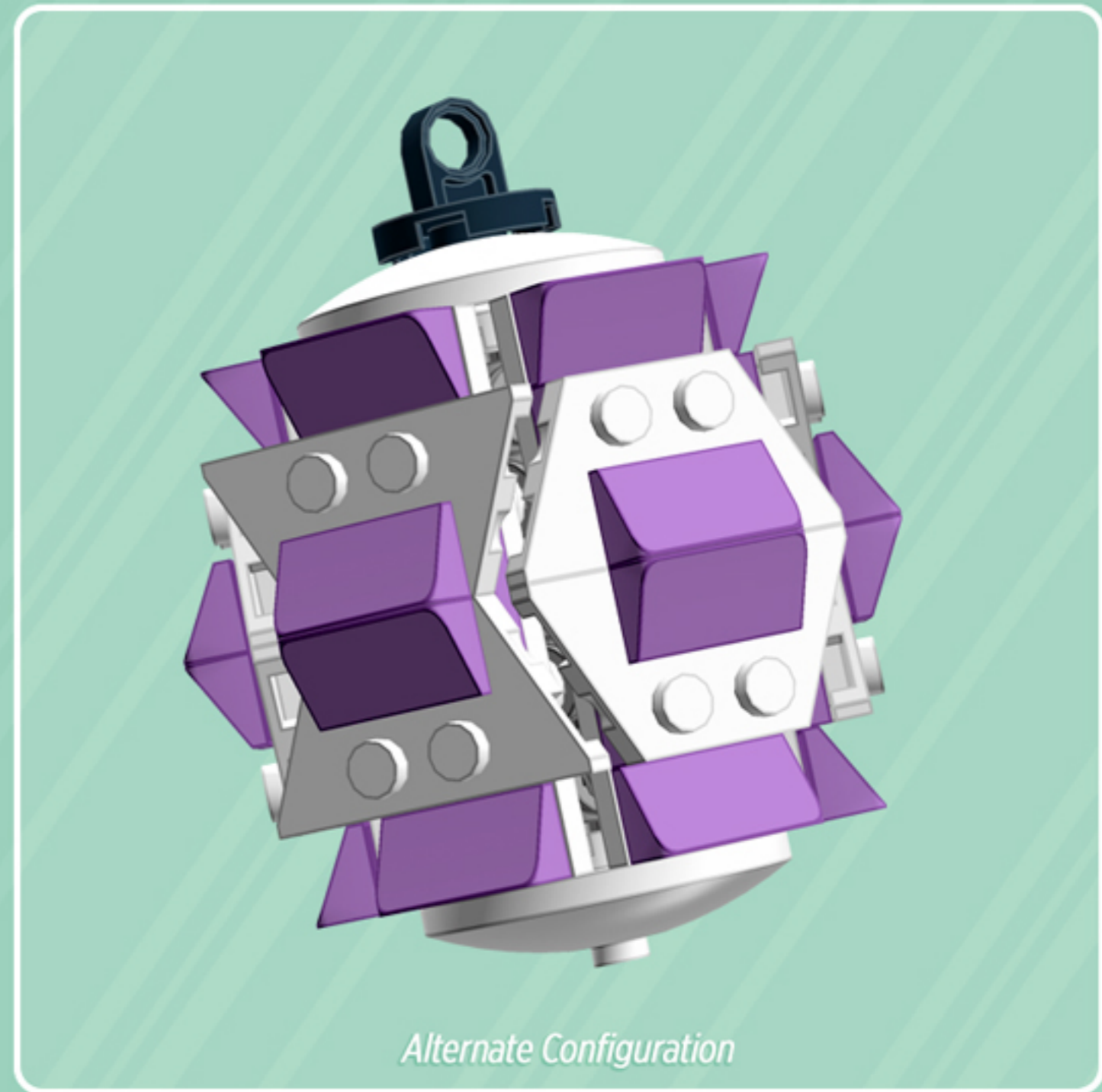
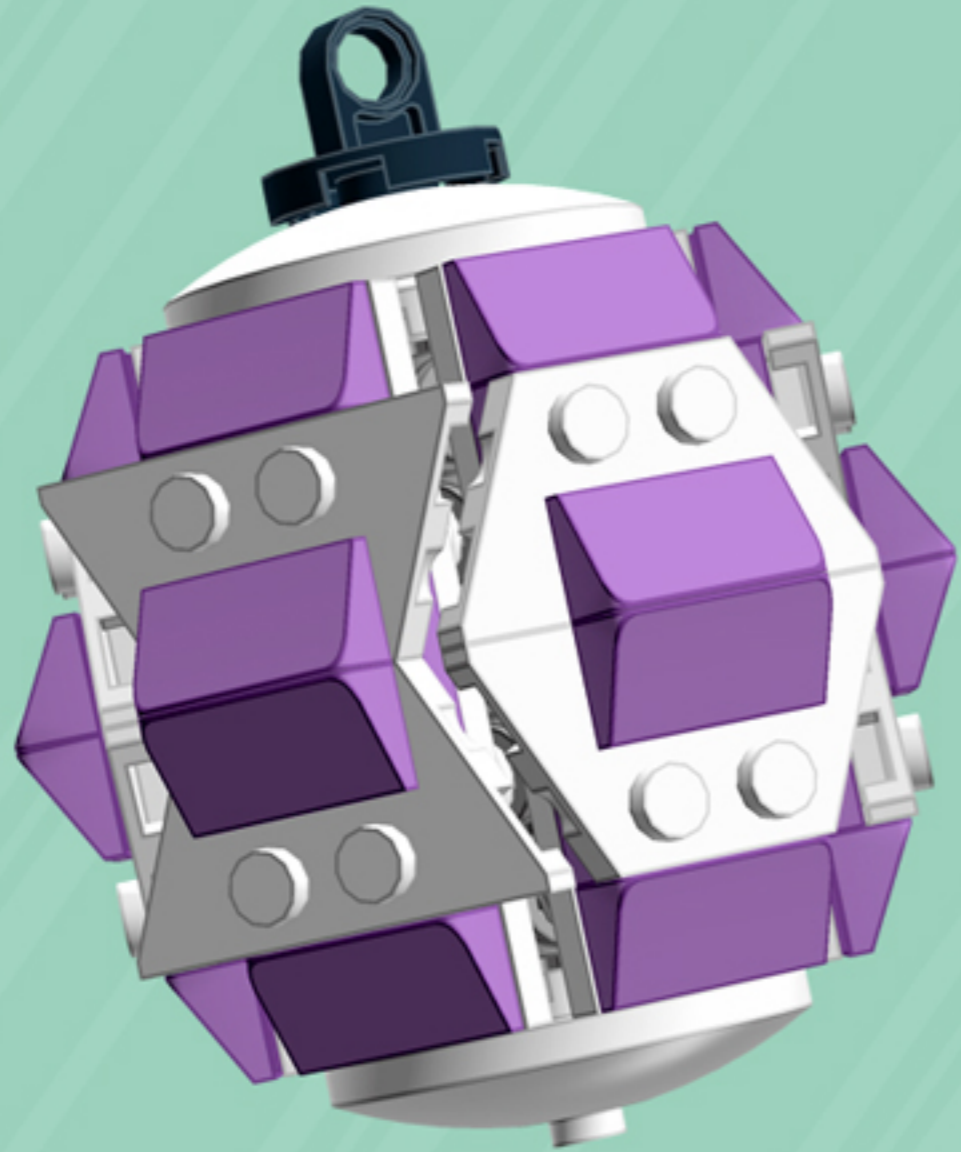

*Alternate Configuration*

*For more fun builds,  
please stop by [chrismcveigh.com](http://chrismcveigh.com),  
visit me at [facebook.com/c.mcveigh.photos](https://facebook.com/c.mcveigh.photos),  
or follow me on twitter [@actionfigured](https://twitter.com/actionfigured)*

*Purchase custom building kits at [shop.chrismcveigh.com](http://shop.chrismcveigh.com)*

*These building guides are for personal use only. Unauthorized duplication, distribution and/or modification of these guides, in whole or in part, is strictly prohibited. The models contained within these guides are the copyright of Chris McVeigh, unless otherwise stated. Unauthorized reproduction of these models for resale, either in whole or as a building kit, is strictly prohibited.*

**© 2016 CHRIS MCVEIGH**

*LEGO is a registered trademark of The LEGO Group.*

