

MODULAR
Arcade
ARCADE MACHINE

A LEGO® project by Chris McVeigh
chrismcveigh.com

• MEDIUM AZURE •

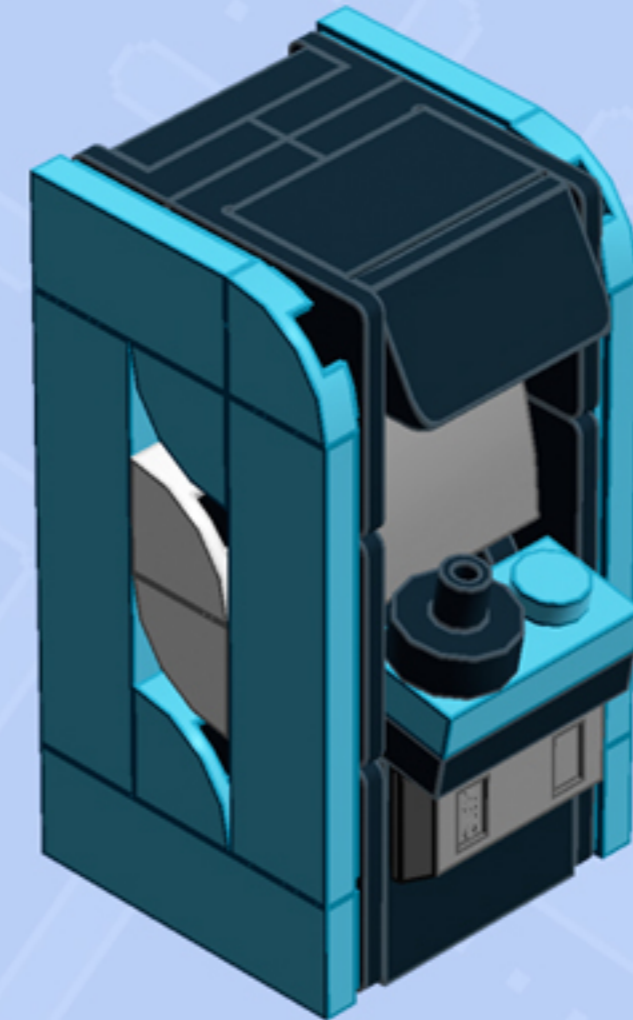



Element ID	Color	Description	Quantity
6089577	Black	Angle Plate 1X2/1X4	2
6016172	Black	Angular Plate 1,5 Top 1X2 1/2	2
6000650	Black	Angular Plate 1.5 Bot. 1X2 2/2	6
300426	Black	Brick 1X2	1
3200026	Black	Brick 1X2 M. 2 Holes Ø 4,87	2
6186675	Black	Plate 1X1 W/3.2 Shaft/1.5 Hole	1
4225201	Black	Plate 1X2 W. Stick 3.18	1
4598528	Black	Plate 1X2 W. Vertical Grip	2
6192346	Black	Plate 2X2, W/ Reduced Knobs	1
379526	Black	Plate 2X6	1
4548180	Black	Roof Tile 1X2X2/3, Abs	1

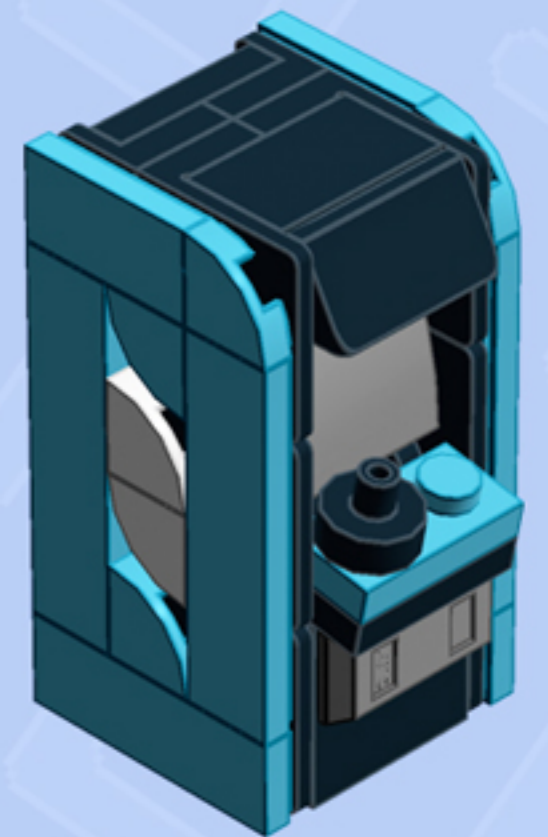

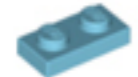
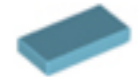
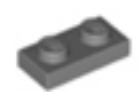

Element ID	Color	Description	Quantity
4211063	Dark Stone Grey	Plate 1X2	4
6150307	Medium Azur	1/4 Circle Tile 1X1	6
4649741	Medium Azur	Flat Tile 1X2	2
6097492	Medium Azur	Flat Tile 1X3	2
4624705	Medium Azur	Flat Tile 1X4	4
4619511	Medium Azur	Plate 1X2	1
4211483	Medium Stone Grey	Connector Peg W. Knob	2
6134378	Medium Stone Grey	Gold Ingot	1
6102357	Medium Stone Grey	Plate W. Bow 2X2X2/3	1
6172366	White	1/4 Circle Tile 1X1	4

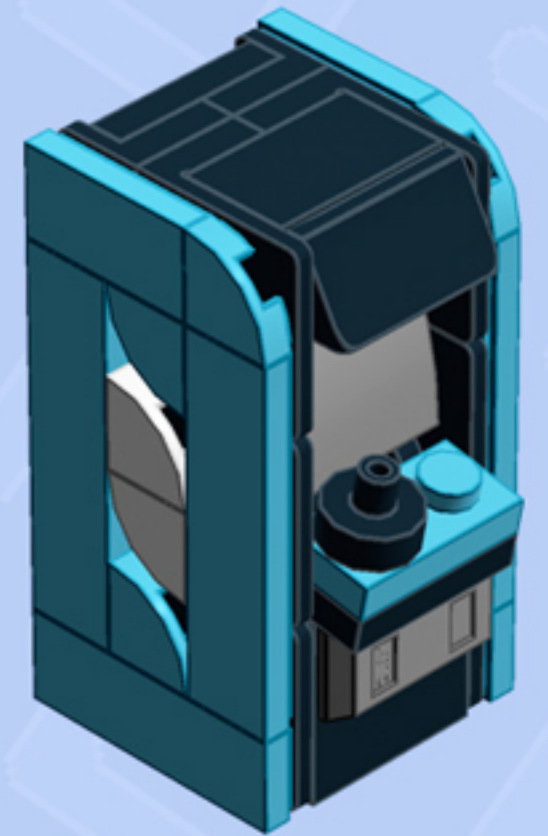

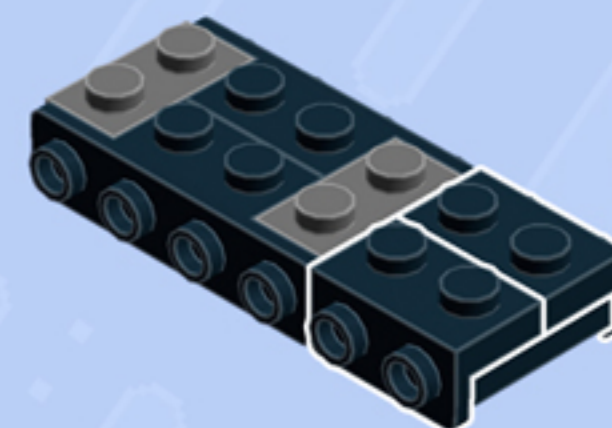
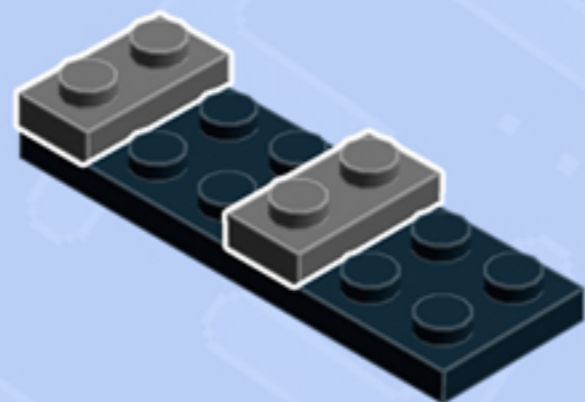
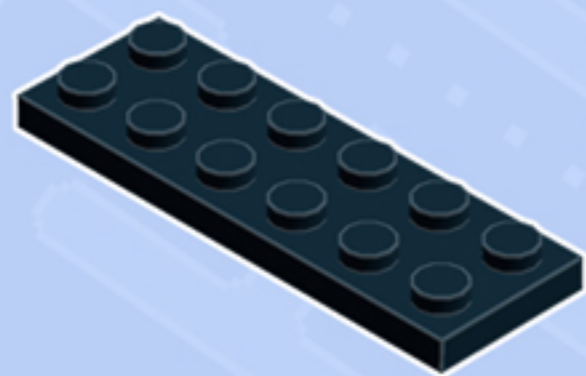

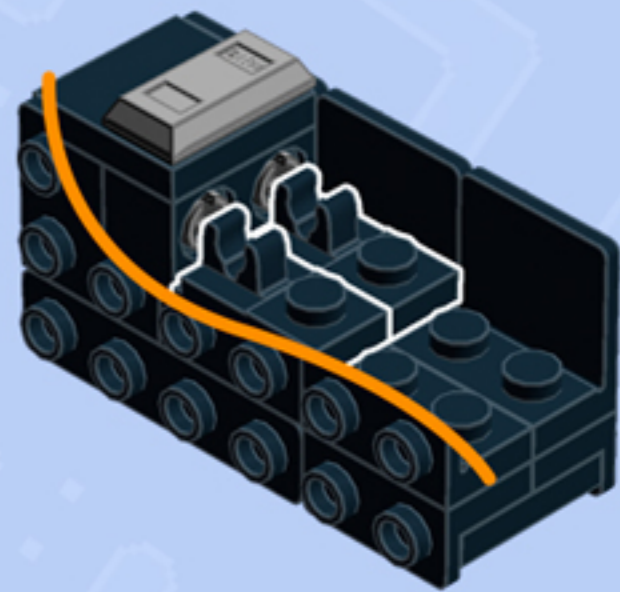
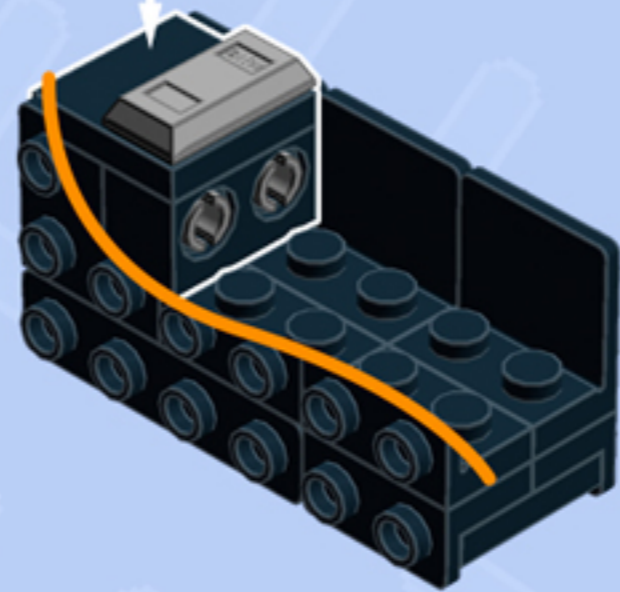
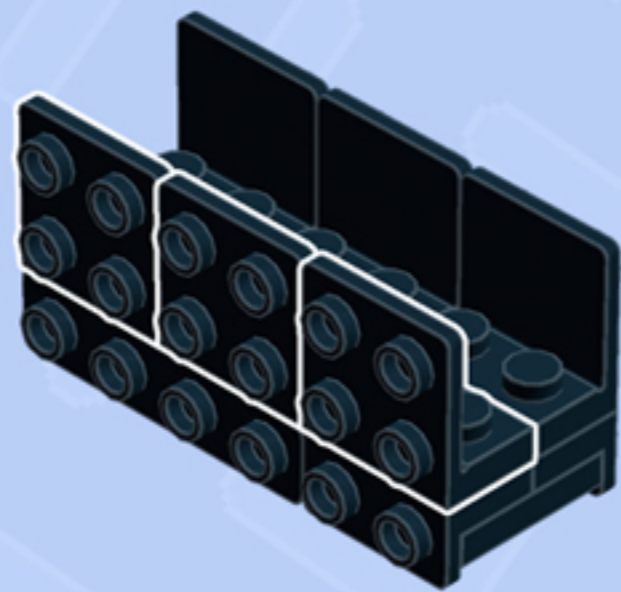
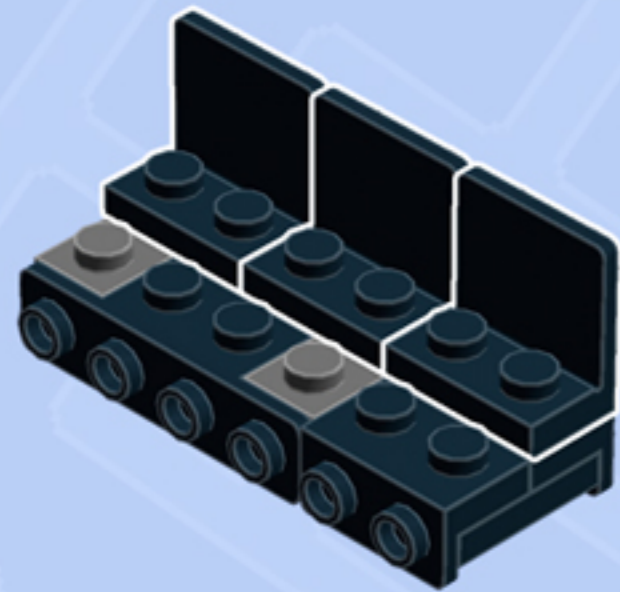

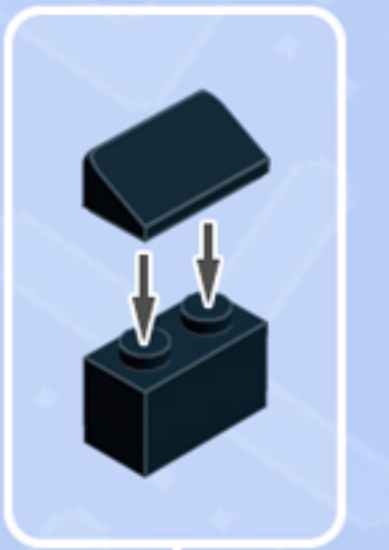
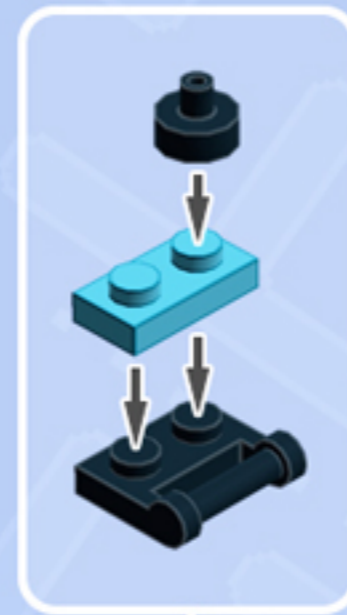
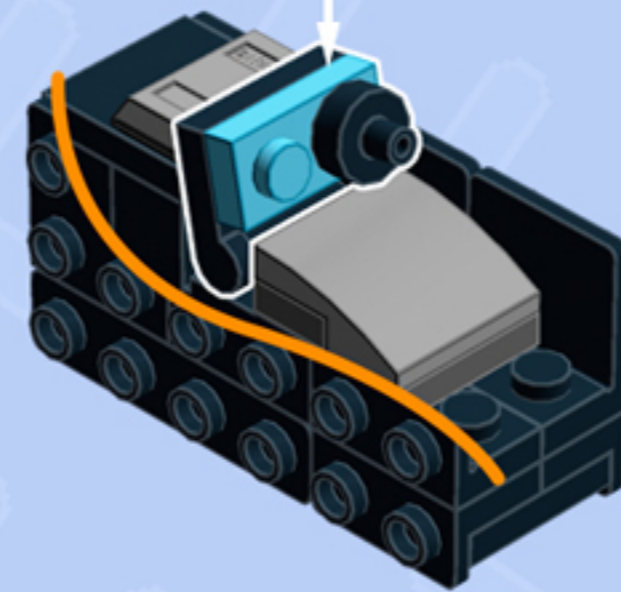
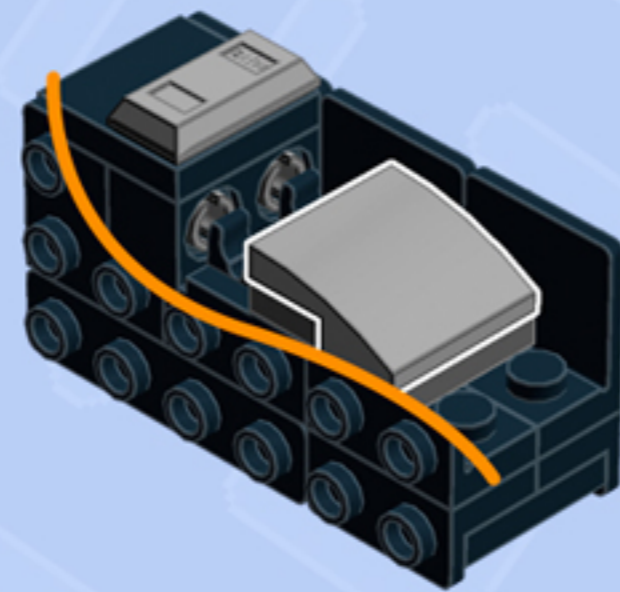
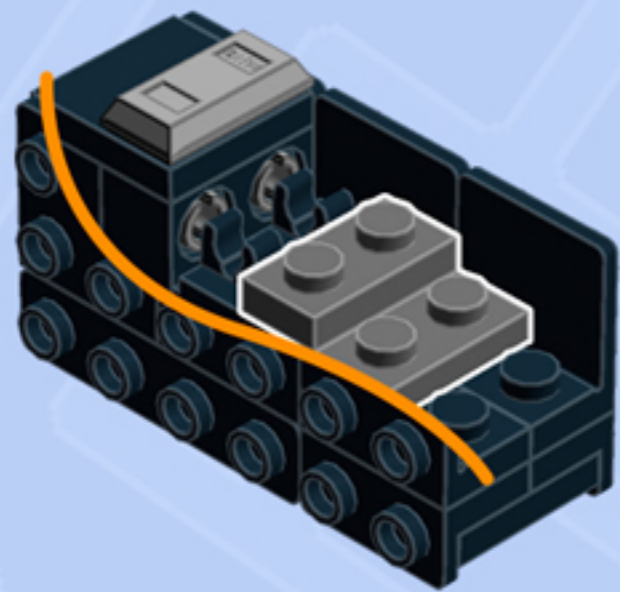

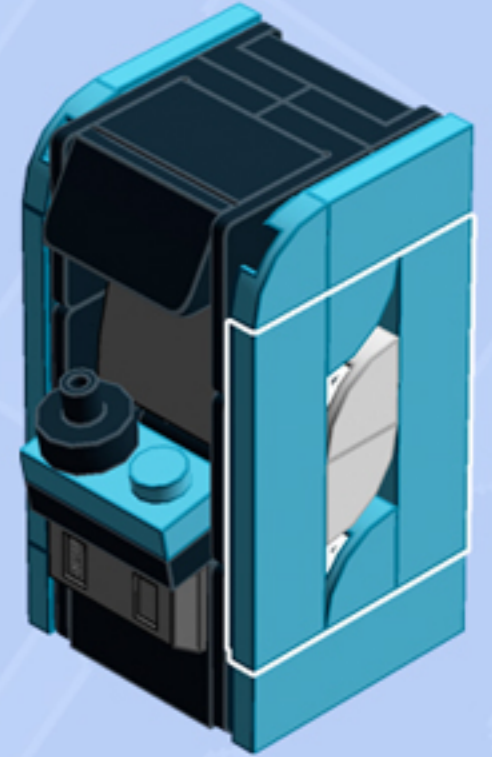
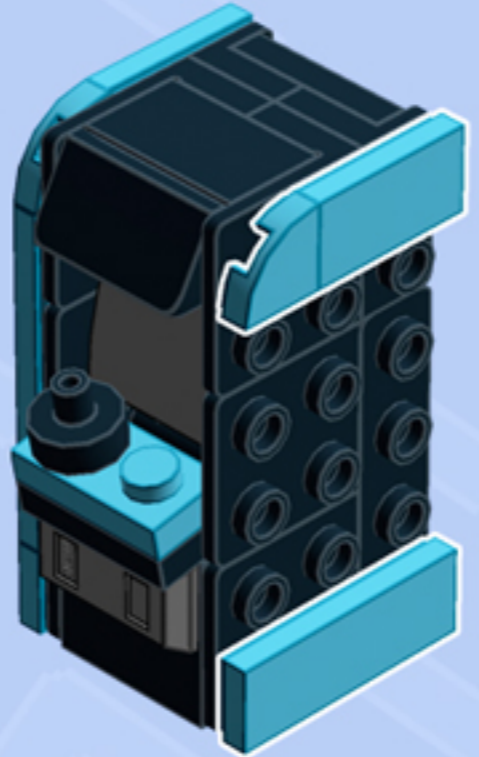
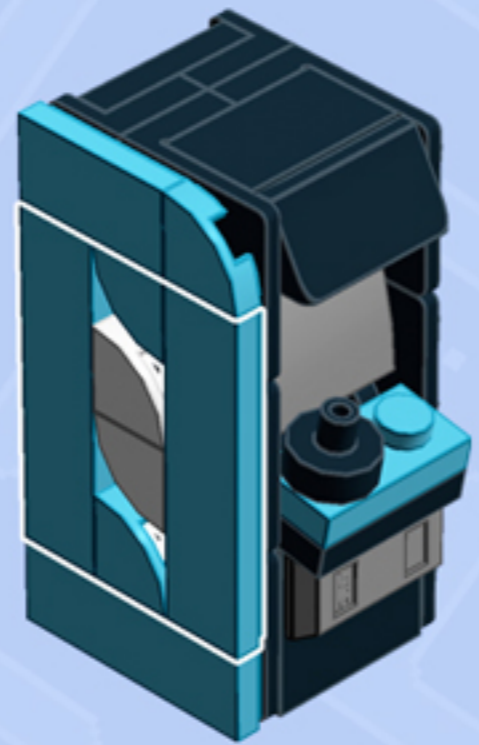
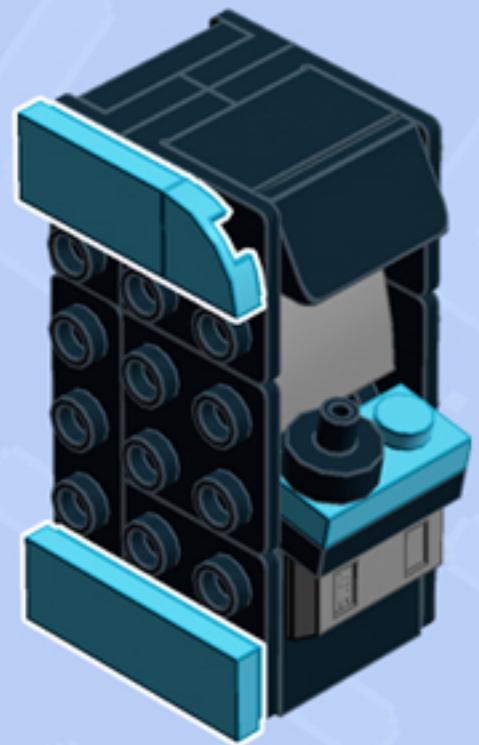



Connect to Wall Unit 4x8!

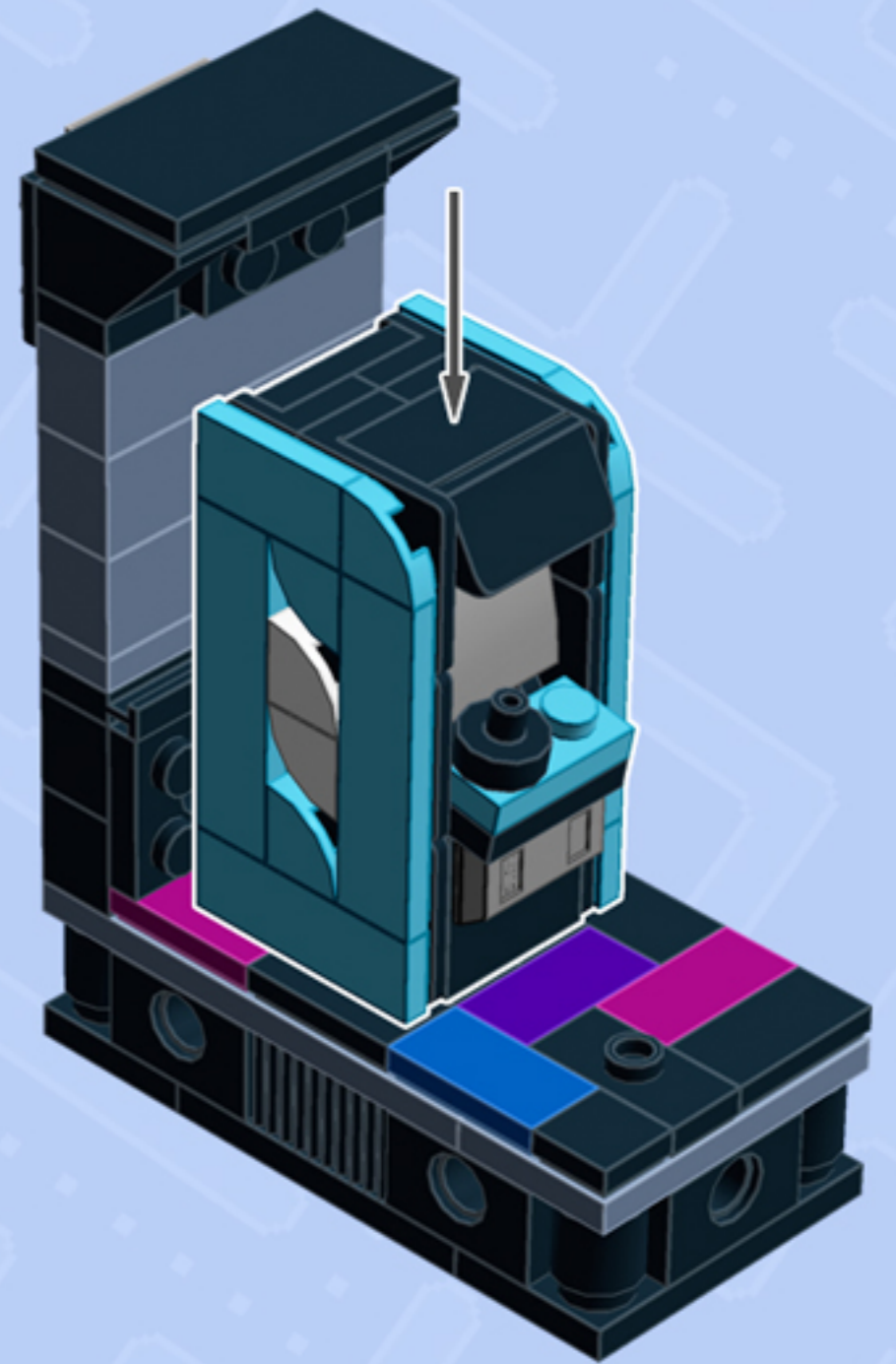
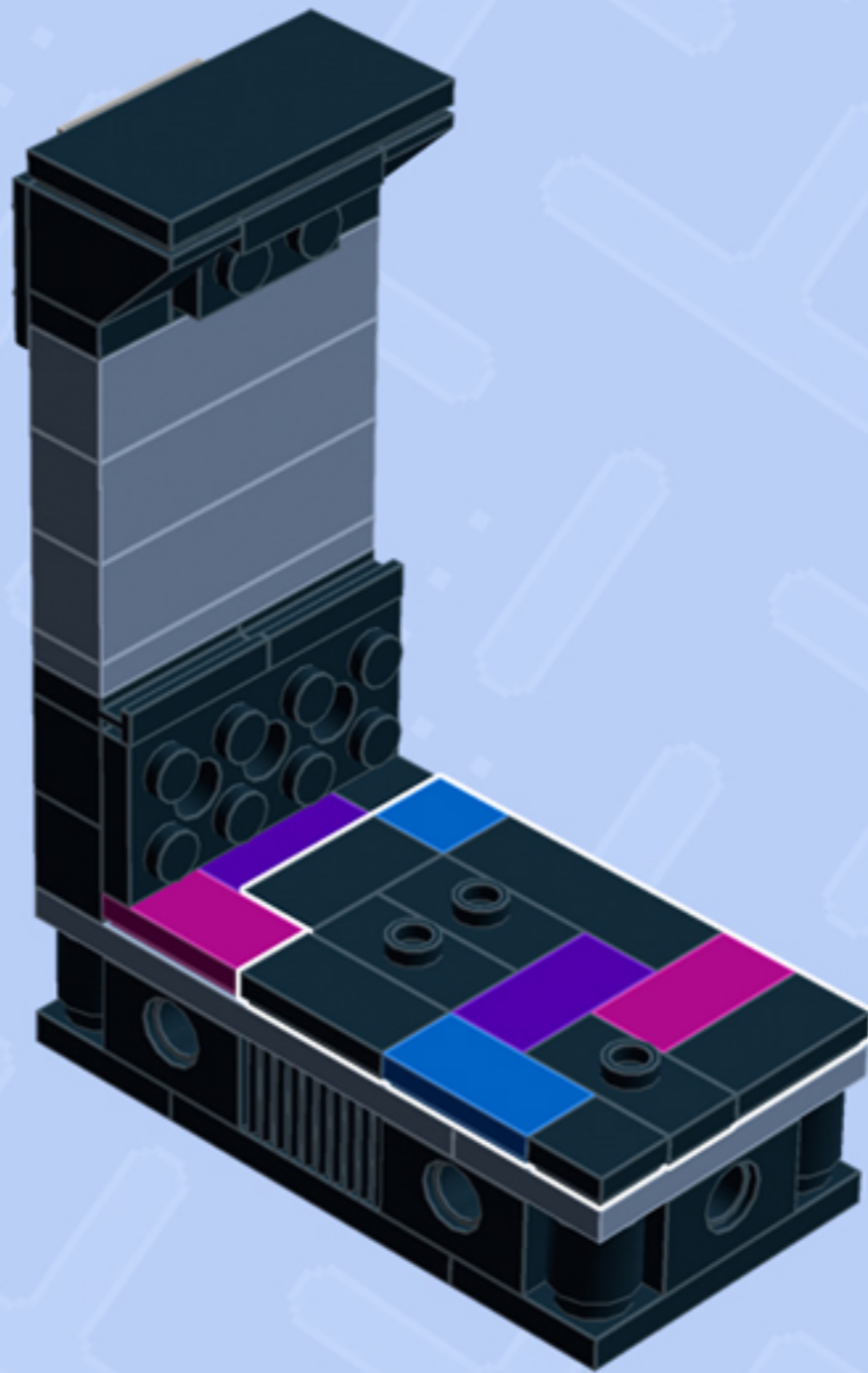

*Wall Unit 4x8 building guide available separately.
Configure the floor as shown to correctly seat Arcade Machine.*

*For more fun builds,
please stop by chrismcveigh.com,
visit me at facebook.com/c.mcveigh.photos,
or follow me on twitter [@actionfigured](https://twitter.com/actionfigured)*

Purchase custom building kits at shop.chrismcveigh.com

These building guides are for personal use only. Unauthorized duplication, distribution and/or modification of these guides, in whole or in part, is strictly prohibited. The models contained within these guides are the copyright of Chris McVeigh, unless otherwise stated. Unauthorized reproduction of these models for resale, either in whole or as a building kit, is strictly prohibited.

© 2018 CHRIS MCVEIGH

LEGO is a registered trademark of The LEGO Group.

