

MODULAR
Arcade
PINBALL MACHINE

A LEGO® project by Chris McVeigh
chrismcveigh.com

• FLAME YELLOW •

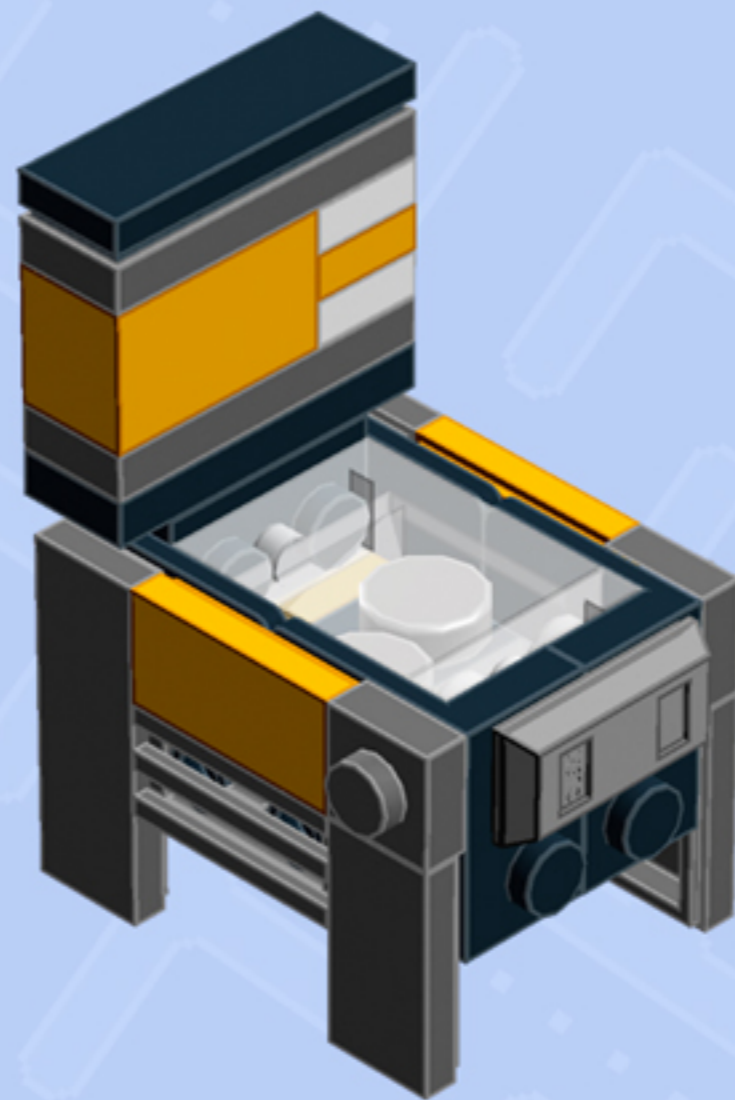



Element ID	Color	Description	Quantity
6117973	Black	Angle Plate 1X2 / 2X2	2
6016172	Black	Angular Plate 1,5 Top 1X2 1/2	1
6000650	Black	Angular Plate 1.5 Bot. 1X2 2/2	2
4558954	Black	Brick 1X1 W. 1 Knob	2
4558170	Black	Flat Tile 1X3	1
302326	Black	Plate 1X2	2
362326	Black	Plate 1X3	1
4211052	Dark Stone Grey	Flat Tile 1X2	2
4568734	Dark Stone Grey	Flat Tile 1X3	2
4210719	Dark Stone Grey	Plate 1X1	2
4211133	Dark Stone Grey	Plate 1X3	2

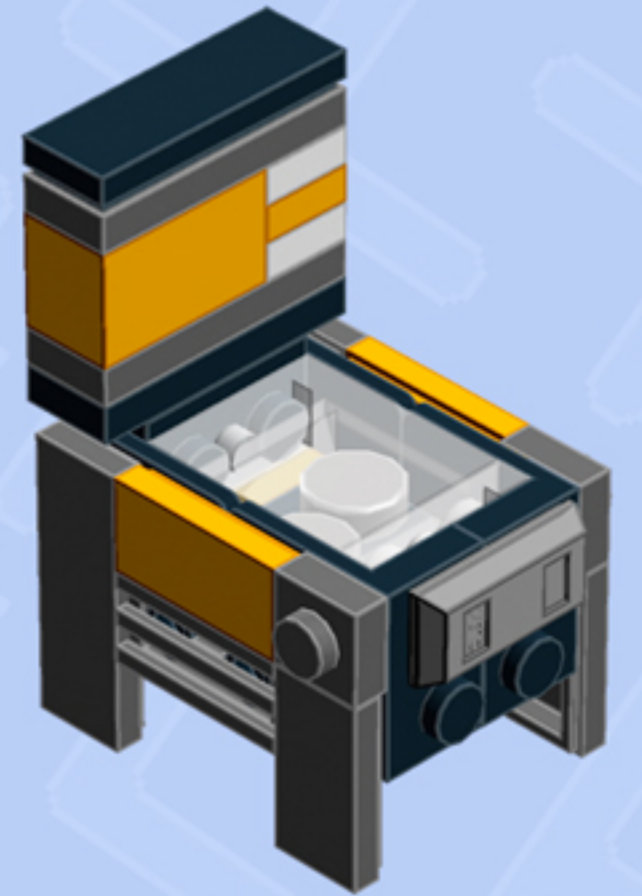



Element ID	Color	Description	Quantity
4210631	Dark Stone Grey	Radiator Grille 1X2	2
6003003	Flame Yellowish Orange	Brick 1X2	1
4622062	Flame Yellowish Orange	Flat Tile 1X2	2
6073040	Flame Yellowish Orange	Plate 1X1	1
6028736	Flame Yellowish Orange	Plate 1X2	2
6134378	Medium Stone Grey	Gold Ingot	1
6138964	Silver Metallic	Flat Tile 1X1, Round No. "47"	2
3000840	Transparent	Plate 1X1	2
4167842	Transparent	Plate 1X2	2
6000740	Transparent	Wall Element 1X2X2	1
302401	White	Plate 1X1	2

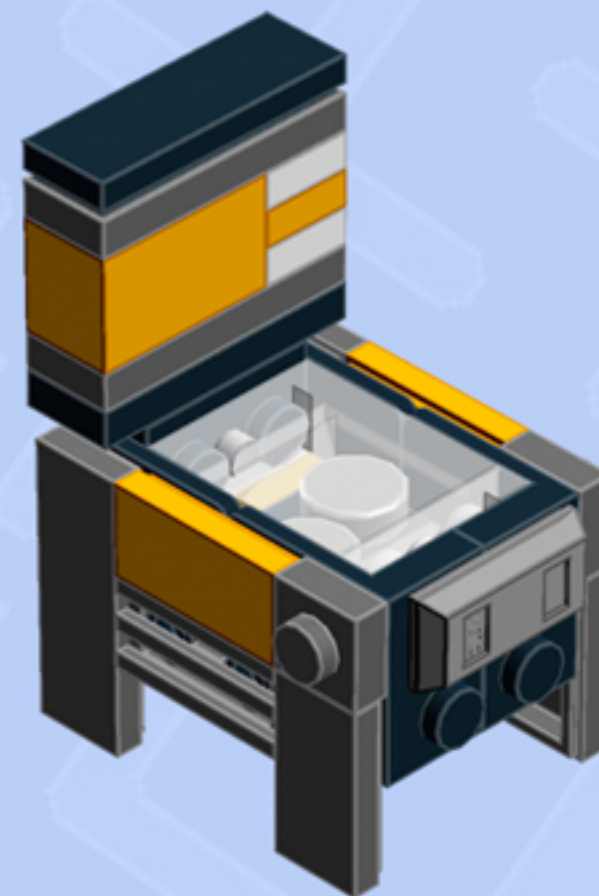



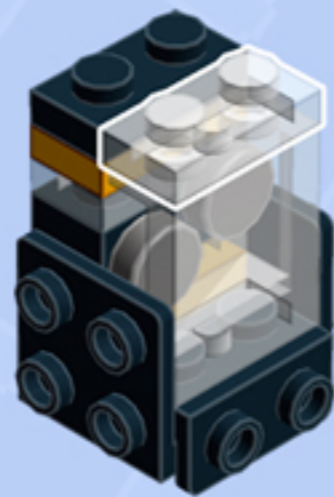
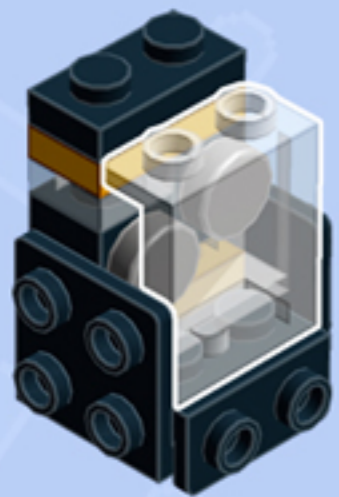

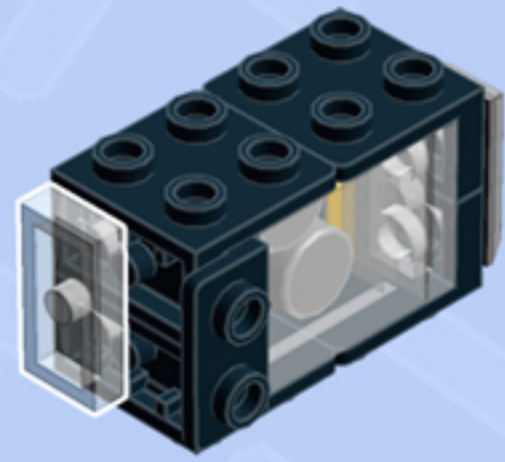
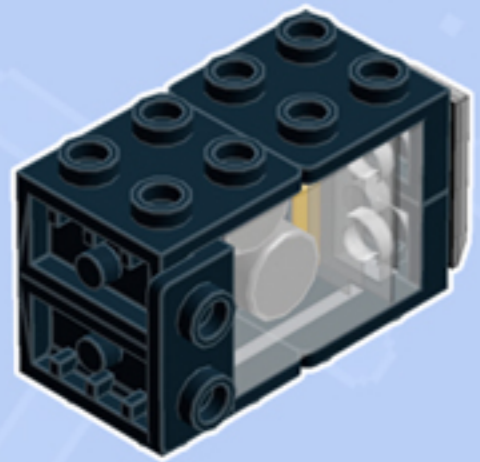

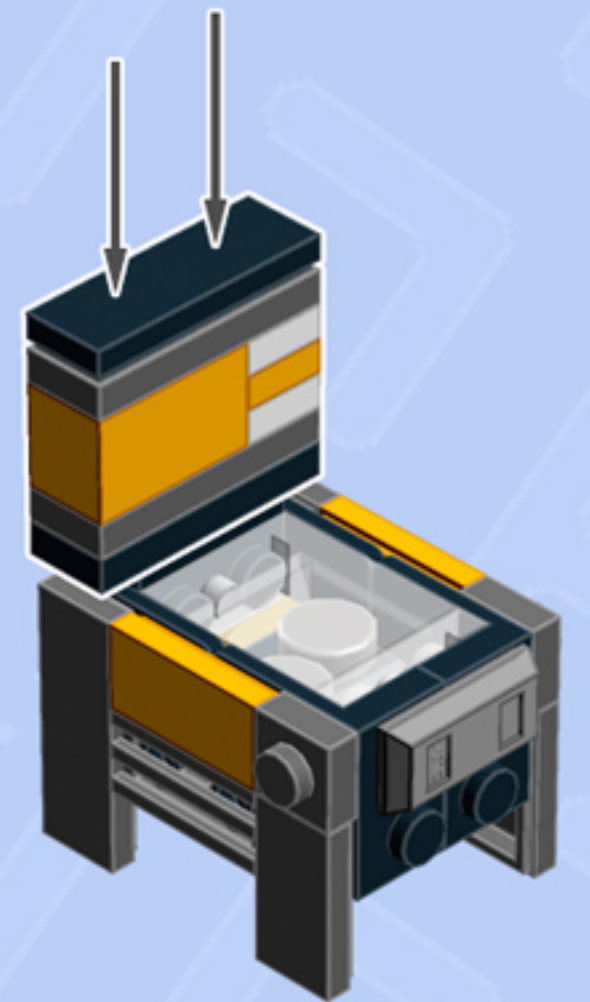
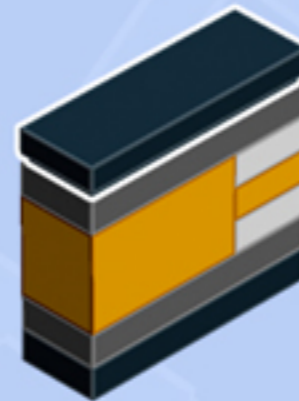



Connect to Wall Unit 4x8!

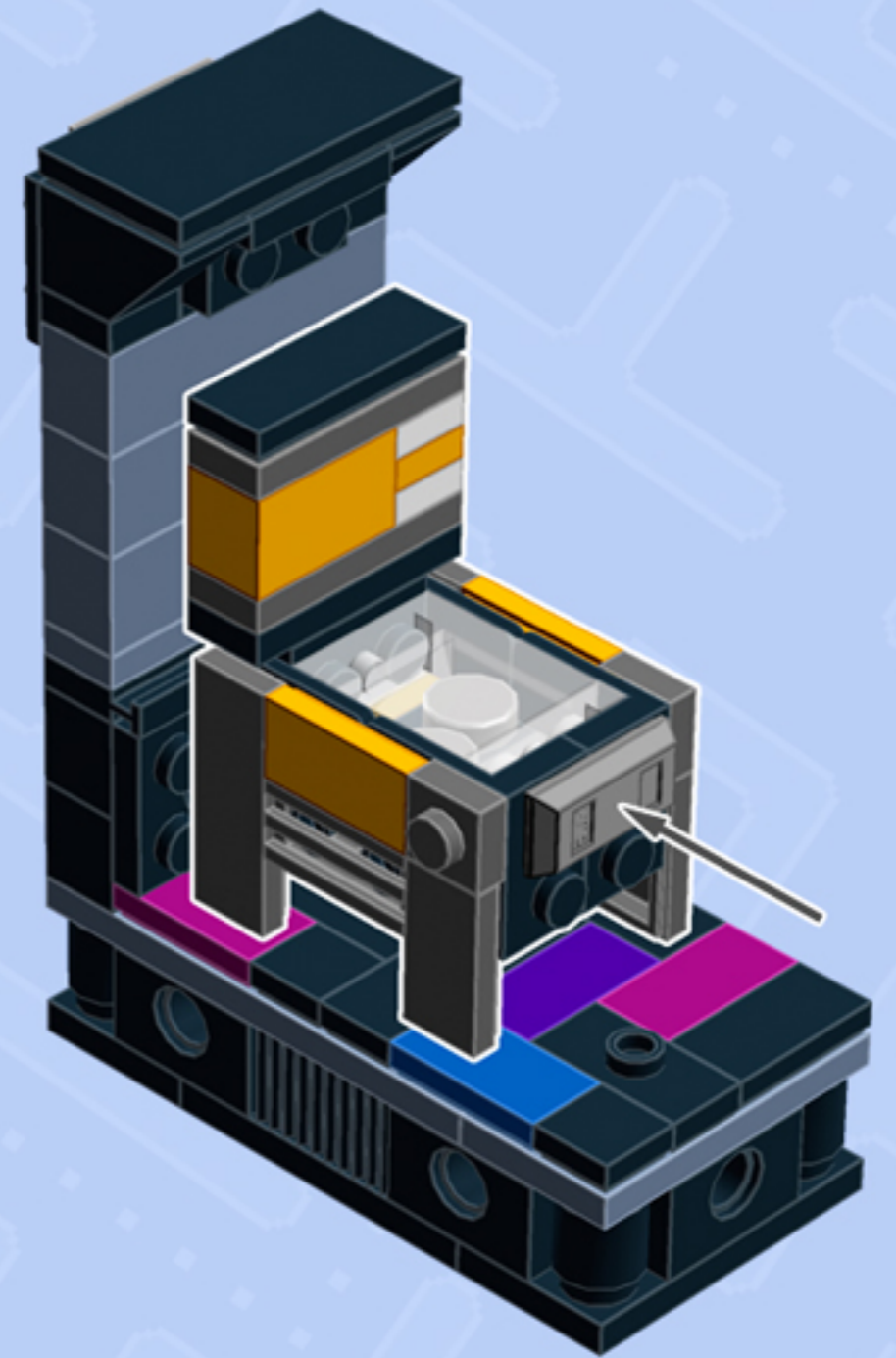
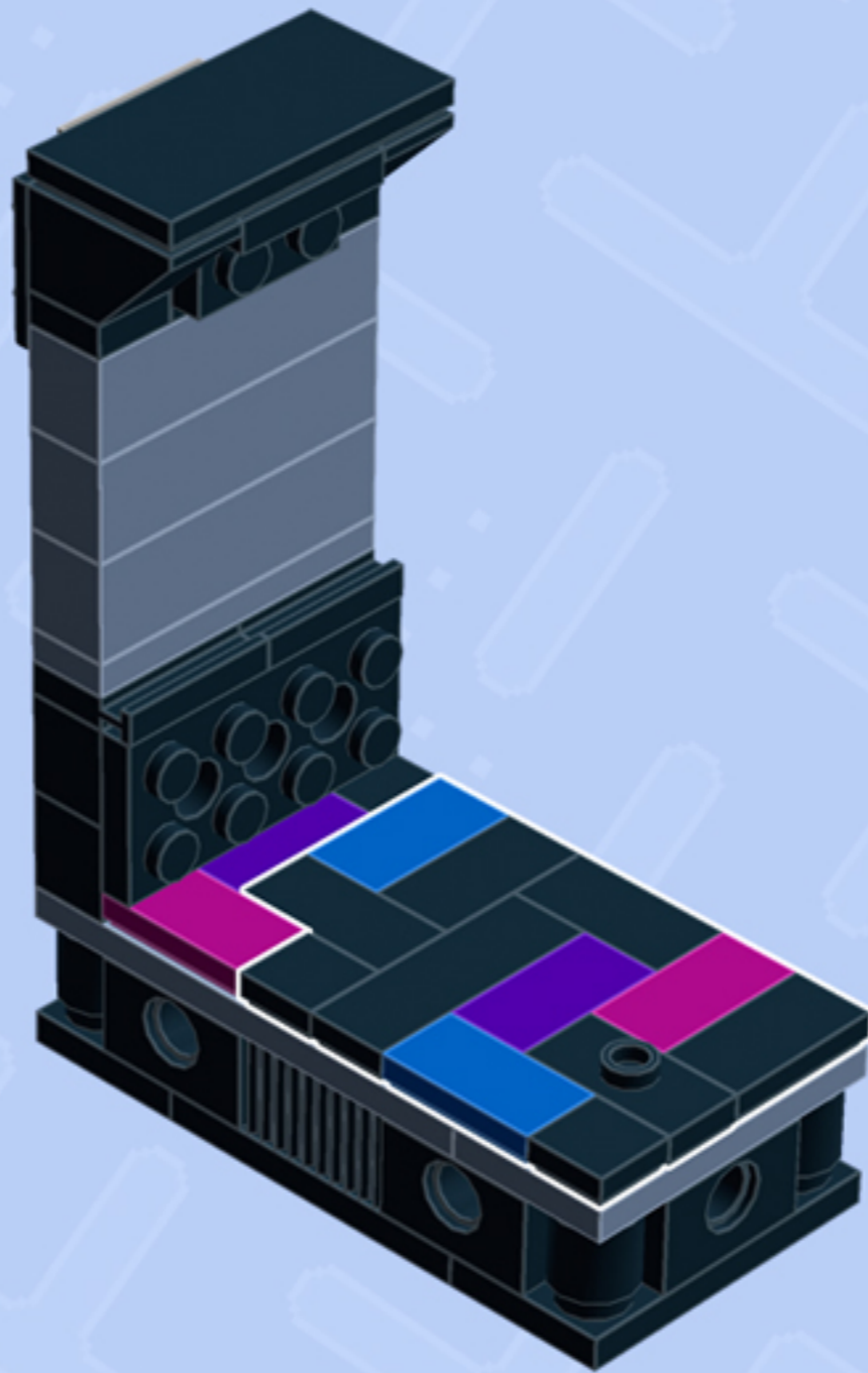
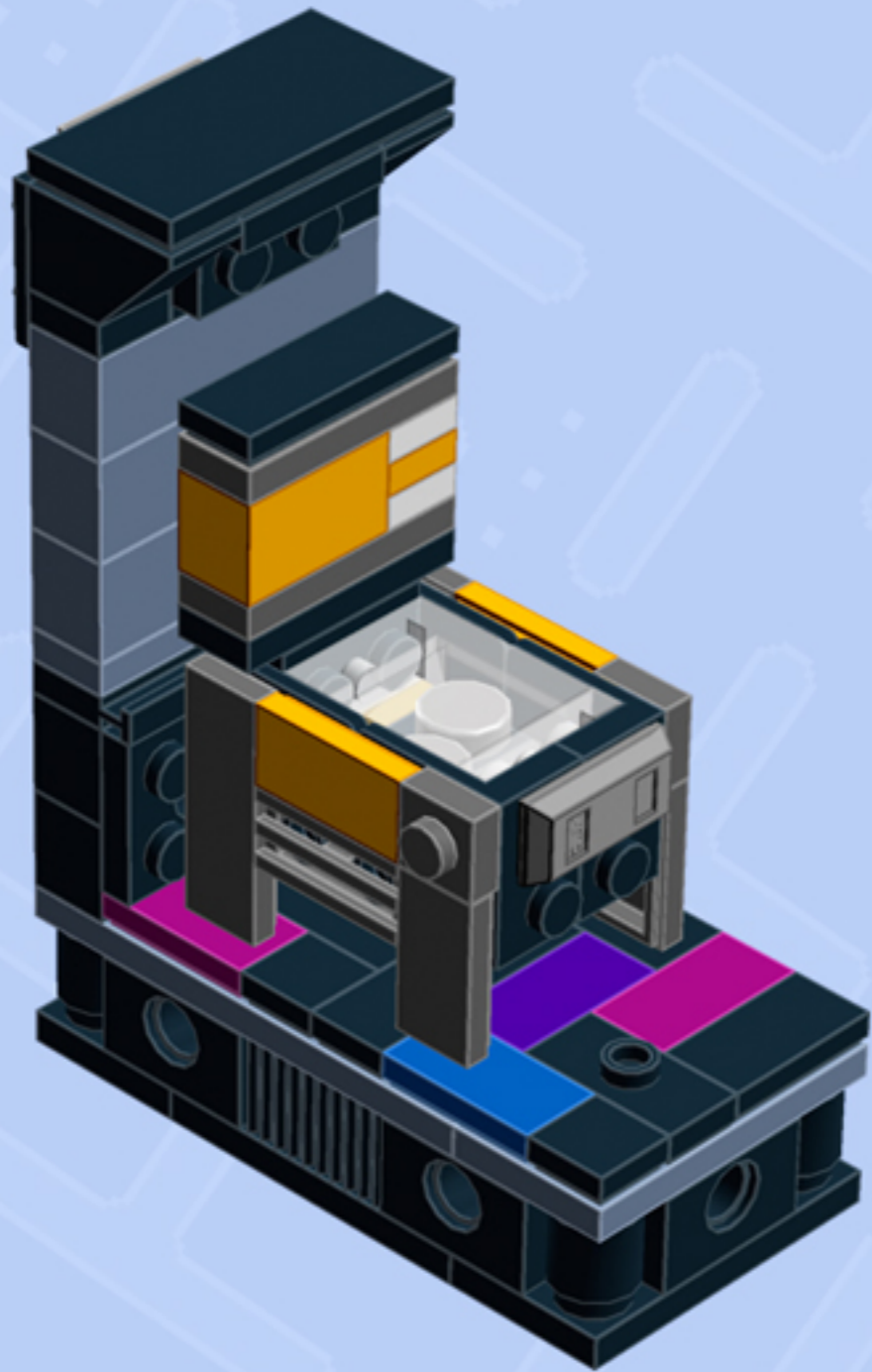

*Wall Unit 4x8 building guide available separately.
Configure the floor as shown to correctly seat Pinball Machine.*

*For more fun builds,
please stop by chrismcveigh.com,
visit me at facebook.com/c.mcveigh.photos,
or follow me on twitter [@actionfigured](https://twitter.com/actionfigured)*

Purchase custom building kits at shop.chrismcveigh.com

These building guides are for personal use only. Unauthorized duplication, distribution and/or modification of these guides, in whole or in part, is strictly prohibited. The models contained within these guides are the copyright of Chris McVeigh, unless otherwise stated. Unauthorized reproduction of these models for resale, either in whole or as a building kit, is strictly prohibited.

© 2018 CHRIS MCVEIGH

LEGO is a registered trademark of The LEGO Group.

